

Earthquake-safe Buildings

A Series of Educational Articles for Developing Nations to Improve the
Earthquake Safety of Buildings

Andrew Charleson

First Edition, March 2022

A Publication of the World Housing Encyclopedia, EERI



This tutorial was first published by the Earthquake Engineering Research Institute, a nonprofit corporation, in 2022. The Earthquake Engineering Research Institute is the leading non-profit membership organization dedicated to understanding earthquake risk and increasing earthquake resilience in communities worldwide.

This tutorial was written and reviewed by volunteers, all of whom participate in EERI and IAEE's World Housing Encyclopedia project.

Any opinions, findings, conclusions, or recommendations expressed herein are the author's and do not necessarily reflect the views of any organization.

Copies of this publication may be downloaded from the World Housing Encyclopedia website at <http://www.world-housing.net/>.

This publication is intended to be translated into other languages and to be modified as required to suit the conditions in those countries, with acknowledgement to EERI and removal of EERI's logo and branding. Permission from the publisher to disseminate part or all of this publication is unnecessary.

Acknowledgements:

This document was developed and reviewed by an international team of experts from The World Housing Encyclopedia project, who volunteered their time and knowledge. Comments from the following reviewers have been especially appreciated: Svetlana Brzev, Marjorie Greene, Shannon Spiers, Dustin Cook, Lars Abrahamczyk and Rezi Imani. Thanks to Brijhette Farmer for drawing the diagrams. Unless otherwise noted, all photographs were taken by Andrew Charleson.

About the World Housing Encyclopedia:

The World Housing Encyclopedia (WHE) is an Encyclopedia of Housing Construction in Seismically Active Areas of the World, hosted by the Earthquake Engineering Research Institute (EERI) and the International Association for Earthquake Engineering (IAEE). The goals of the WHE are:

- To share knowledge on housing construction practices
- To encourage use of earthquake-resistant technologies
- To develop guidelines and technical resources for improving seismically vulnerable construction
- To offer services and technical support to communities across the world on earthquake resistant housing technologies

Table of Contents

- Article 1. India and Earthquakes
- Article 2. Avoiding Soil and Foundation Problems during Earthquakes
- Article 3. Three Structural Systems to Resist Earthquakes
- Article 4. Why Walls Are the Best Earthquake-resistant Structural Elements
- Article 5. Are Walls in Buildings Helpful during Earthquakes?
- Article 6. How Do Buildings with Reinforced Concrete Columns and Beams Work in Earthquakes?
- Article 7. Principles for Earthquake-safe Masonry Buildings
- Article 8. Tying Parts of Buildings Together to Resist Earthquakes
- Article 9. Local Wisdom and Building Safety in Earthquakes
- Article 10. Infill Walls and How They Affect Buildings during Earthquakes
- Article 11. A Common Structural Weakness to Avoid: Soft Story
- Article 12. A Common Structural Weakness to Avoid: A Discontinuous Wall
- Article 13. A Common Structural Weakness to Avoid: Short Column
- Article 14. Preventing a Building from Twisting during Earthquake
- Article 15. Why Buildings Pound Each Other during Earthquakes
- Article 16. Construction Codes and Standards
- Article 17. What to Look for in Building Regulations
- Article 18. What to Expect from a Building Designed according to Codes
- Article 19. Importance of Checks during the Design of Buildings
- Article 20. Importance of Checks during the Construction of Buildings
- Article 21. Preventing Damage to Non-structural Components
- Article 22. Retrofitting Buildings against Earthquake
- Article 23. Advanced Earthquake-Resilient Approaches for Buildings
- Article 24. Urban Planning and Earthquake Safety
- Article 25. Tsunamis and Buildings

Introduction

The need for this publication became apparent after a 2019 survey of building industry stakeholders in Yogyakarta, Indonesia. One hundred and forty engineers, architects, contractors and building owners were asked to suggest changes that their building departments could make in order to improve building safety during earthquakes. The most prevalent suggestion was that building departments should take on an educational role. The survey respondents believed that information, including the earthquake hazard, effects of earthquakes on buildings, and building regulations related to building safety should be readily available to all stakeholders, as well as to the staff of building departments themselves.

The 25 information articles in this document have been written initially for people in the building industry as well as the general public of Indonesia's third largest city, Bandung. Over the years, the author has spent many months there. Although the articles are somewhat context-specific, they are intended to function like a template. The intention is that the articles will be modified to suit local contexts, including construction materials and methods. Then, if necessary, be translated into local languages, for the many earthquake-affected cities and regions in the developing world.

Having developed this educational resource of articles, The World Housing Encyclopedia seeks partners in developing countries to translate, edit as necessary and disseminate them. A partner must possess a desire to improve the earthquake-safety of local buildings, to be experienced in earthquake-resistant design, to be highly reputable and respected locally, and in a position of influence in the local building industry. After editing and translating the articles to increase their local relevance, a partner will disseminate them.

Potentially, the most strategic partner is a local or regional building department. Ideally, it would host the local version of the articles on its website, and even make printed copies available for those seeking building permits as well as the general public. Alternatively, a partner might be a government department, a national earthquake society, a consortium of university staff, or a large consulting engineering firm. A partner's input into the final local version of the articles will be acknowledged and this will help raise the partner's public profile. The partner might also offer to answer queries arising from the articles.

As well as posting the articles on a website and or printing articles for those visiting in person, additional dissemination methods are possible. For example, the articles could be published as a series of newspaper or magazine articles. Magazines read by building professionals and building and home owners could be targeted. Perhaps articles could also be promoted to appropriate professional education and construction training institutions.

Finally, some guidance for translators and editors modifying articles to suit local contexts:

- Review suggestions for "References". Add references particularly relevant to your city or country and remove any that could be unhelpful.
- Replace any images or diagrams with those more appropriate to your local situation and remove any you consider irrelevant.
- Rephrase text as required for your country. Use local place names where appropriate to make articles as specific and as relevant as possible to your city or region. As an example, in Indonesia the phrase "local wisdom" is very popular (see Article 9), but in other countries "traditional construction" might be more appropriate.
- Review critically the content of each article to ensure your local version will be fully applicable to your readership. Check that assumptions made in the template articles are valid for you. For example, when discussing how to tie buildings together in Article 8, it is assumed that suspended concrete slabs are present. But in some countries, wooden floors are commonly used in conjunction with masonry walls.
- Consider the format in which the articles are to be published. If they are being published as one document, then there is no need to have the introductory footnote in each article. However, that footnote is appropriate when the articles are published, say, as a series in a newspaper or magazine.

- Remember that the articles are specifically written for the general public. The articles therefore are to be understood by ordinary people. In any rewriting and translation, avoid technical terms or jargon. Strive for clarity and readability.
- When you have edited and or translated the articles, please email a pdf version to The World Housing Encyclopedia (whe@eeri.org) where it will be also posted on its website.
- If you have any queries during the translation or dissemination process, please contact Andrew Charleson at Andrew.w.charleson@gmail.com.
- Thank you to partners with The World Housing Encyclopedia to improve the earthquake safety of buildings, but especially housing, in your communities.

Earthquake-safe Buildings

Article 1. India and Earthquakes

Decades, sometimes centuries, of relative slip between two adjacent large rock masses result in building up of stresses at their “locked” junction. The stress and energy are released by sudden and violent rupture of rock, causing an earthquake. Tectonic activities in the Himalayan range, and some intra-plate activities have caused a number of earthquakes in the Indian subcontinent leading to thousands of casualties, a greater number of injuries, and significant financial losses. Figure 1 shows the locations and magnitudes of some prominent earthquakes in the subcontinent.

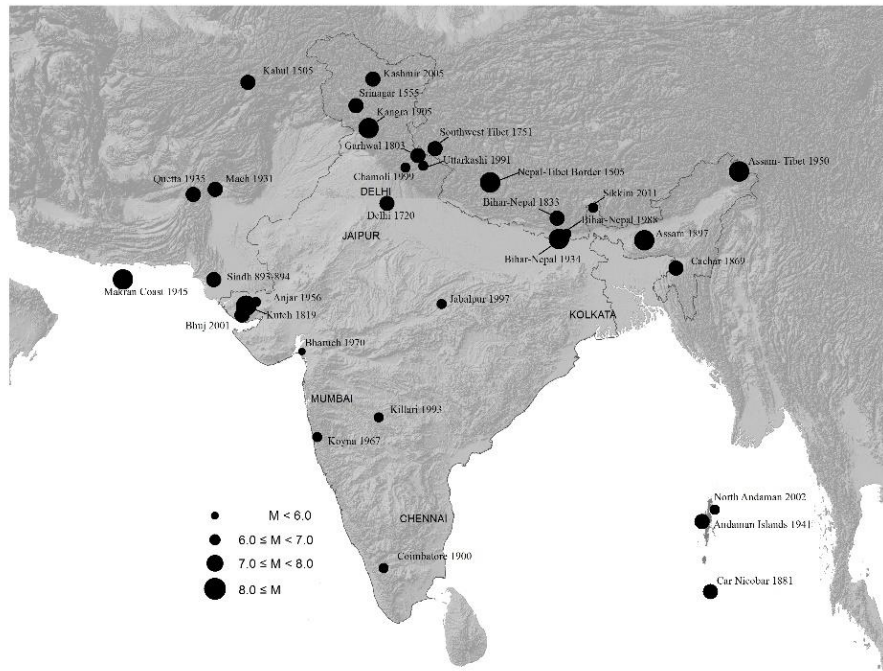
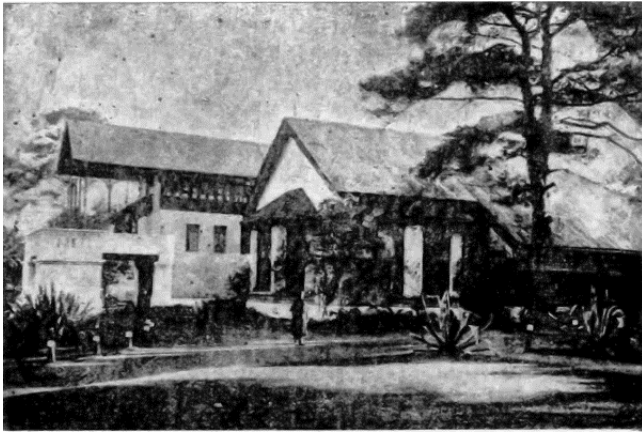

Figure 1. Prominent earthquakes in the Indian subcontinent (adopted from Jain (2016) under the terms of Creative Commons Attribution 4.0 International License available at <http://creativecommons.org/licenses/by/4.0>).

Northern states and union territories of India such as Jammu, Kashmir, Ladakh, Himachal Pradesh, Punjab, Delhi, Uttarakhand, Uttar Pradesh, Bihar and West Bengal are vulnerable to moderate to severe ground shaking. The north-eastern states such as Assam and Manipur have experienced severe shaking in the past. Severe shaking has also been observed in other states such as Gujarat and Maharashtra because of intra-plate activities. During an earthquake the ground moves to-and-fro quickly and randomly in all directions. Ground movements during a large earthquake may cause you to become so unsteady you can't stand. The ground itself can be affected by this shaking, causing earthquake-induced landslides, and liquefaction where wet soil turns to mud. But usually, the buildings we live and work in every day, will suffer the most (Figure 2).

Buildings vibrate, shaking side-to-side during an earthquake. The higher parts or floors of buildings move sideways further than those below as buildings bend and distort during the shaking (Figure 3). This puts enormous stress on the structure supporting buildings, like columns, beams and walls. It's like you standing tall with both feet on the ground, and a friend pushing you gently from behind. Your head and shoulders will move much more than your knees and shins. The muscles in your feet will be doing most of the work to keep you from falling over. This is similar to what a building experiences during an earthquake. Reinforced concrete columns and masonry walls are the most vulnerable. If they get damaged, buildings may collapse. We, our families, friends and others may be among the casualties.



(a) Before collapse

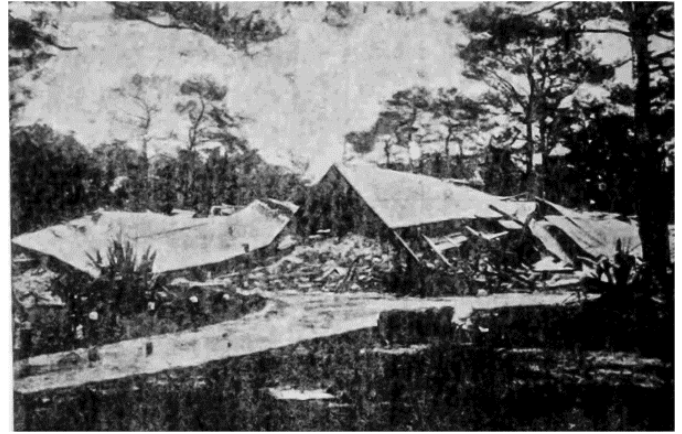

(b) After collapse

Figure 2. A government building in Shillong, Meghalaya affected by 1897 Assam earthquake (Oldham 1899).

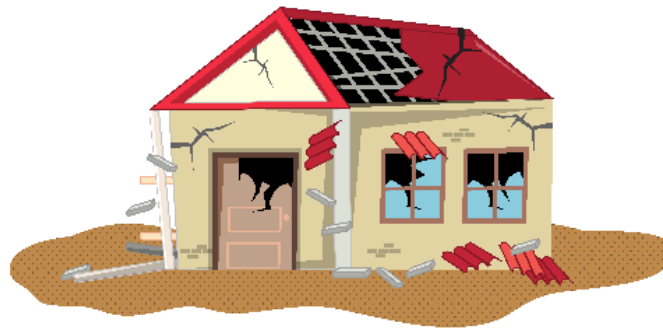

Figure 3. House during earthquake shaking.

Fortunately, it's straight forward and not overly expensive to design and construct buildings to resist earthquakes. Building damage during earthquakes is not inevitable. It can be prevented! Further articles in this series explain how in greater detail. For new buildings in India and in other countries to be both safe and avoid serious damage during earthquakes it's a matter of improving current practice and applying well-known and proven principles and practices. This is how we can keep ourselves, our families, and our future relatives safe during earthquakes.

The chance of a damaging quake severely damaging your building is relatively high for most parts of India. Higher than, for example, you having a serious traffic accident. Earthquake-safe buildings are readily achievable, but they don't happen without greater care than usual.

About this article series:

This is a series of articles about earthquakes, their effects on buildings, and how to ensure that buildings are safe against earthquakes. They are intended for potential owners of new houses and larger buildings and others involved in the building industry. The articles are written by Andrew Charleson and colleagues from the World Housing Encyclopedia (<http://www.world-housing.net/>) which is sponsored by the Earthquake Engineering Research Institute (<https://www.eeri.org/>) and the International Association of Earthquake Engineering (<http://www.iaee.or.jp/>). Manish Kumar has made modifications in the original article to make it reflect the Indian earthquake scenario.

References:

Oldham, R. D., 1899. Report on the Great Earthquake of 12th June 1897. *Memoirs of the Geological Survey of India*, Volume 29, pp. 1-379.

Jain, S. K., 2016. Earthquake Safety in India: Achievements, Challenges and Opportunities, *Bulletin of Earthquake Engineering*, Volume 14, pp. 1337-1436.

Earthquake-safe Buildings

Article 2. Avoiding Soil and Foundation Problems during Earthquakes

Ideally, each of us would like our house or building we occupy to be founded on solid rock. If so, we would eliminate several potentially serious soil failure scenarios affecting our building. During earthquake shaking, soil can behave in ways that are not only strange but dangerous to buildings.

Perhaps the most obvious hazard arises from steep slopes. They are susceptible to rockfalls and landslides, both of which can destroy individual buildings and whole communities. Usually, civil engineering solutions are found to prevent these problems. For example, surface drains can prevent rainwater softening the soil of potential slips that earthquake shaking might activate. Active stabilization of a hillside involving drilling long holes and installing 'ground anchors' to prevent a slip forming involves a greater level of intervention and investment (Figure 1).

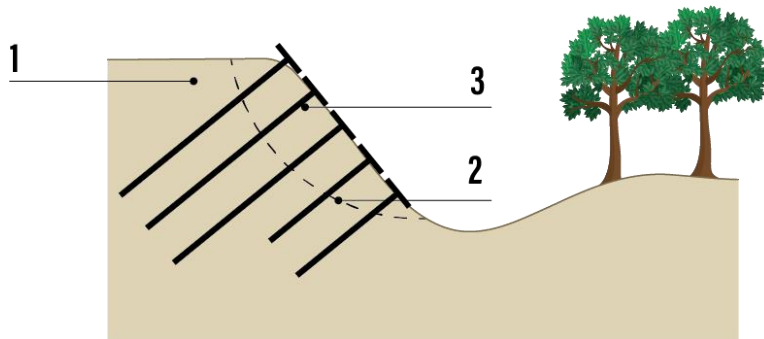

Figure 1. A cross-section through an unstable slope (1). A potential curved slip surface (2) is prevented from sliding by steel bar ground anchors (3) drilled and concreted into the slope.

Surprisingly, a serious earthquake-induced problem can lurk under even the soil of flat sites. This is especially the case where sites are underlain by loose sand under the water table. Earthquake shaking mixes the sand and water into a liquid slurry. Hence the term 'liquefaction'. Buildings founded on this now fluid material sink into it. They tilt, or even completely fall (Figure 2). Search the internet for "buildings liquefaction" to see many images. In extreme cases, such as during the 2018 Palu Indonesia earthquake, many houses were swept away and disappeared into soil that suddenly turned to mud.

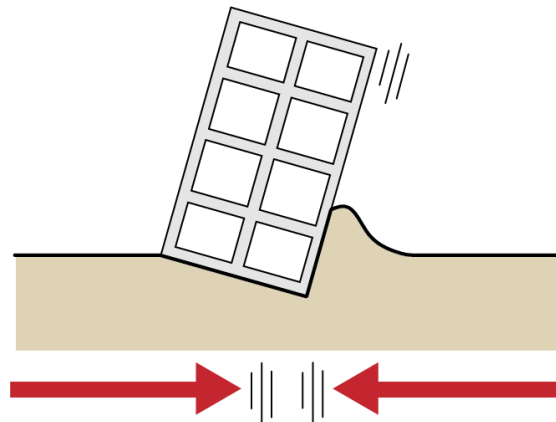

Figure 2. Ground shaking causes some soils to lose strength and liquefy, leading to the building tilting.

These potential hazards involving soils and earthquakes are a reminder for the need of pre-design and construction soil investigations. Soil tests are recommended. Simple tests for small buildings, but more extensive ones for larger projects. Civil engineers require results from these tests to be confident that the soil is capable of supporting the building's weight. Testing usually means drilling below the ground surface to ascertain the types of soils present (Figure 3). Samples are often taken which then may be tested in a laboratory. Especially for larger buildings, clients should engage a geotechnical engineer to arrange for tests, to interpret results and recommend design criteria. For sites on slopes or prone to liquefaction, geotechnical engineers can suggest measures to overcome the potential problems that jeopardize building safety.



Figure 3. A drilling rig sampling soil to be tested in a laboratory.

It is very important for building owners to undertake appropriate soil investigations during the design phase and before construction. This is particularly important for areas with soft soils.

About this article series:

This is a series of articles about earthquakes, their effects on buildings, and how to ensure that buildings are safe against earthquakes. They are intended for potential owners of new houses and larger buildings and others involved in the building industry. The articles are written by Andrew Charleson and colleagues from the World Housing Encyclopedia (<http://www.world-housing.net/>) which is sponsored by the Earthquake Engineering Research Institute (<https://www.eeri.org/>) and the International Association of Earthquake Engineering (<http://www.iaee.or.jp/>).

References:

Charleson, A. W., 2008. *Seismic design for architects: outwitting the quake*. Oxford, Elsevier. Chapter 7, pp. 113-123.

Moller, E., 2016. Demonstrate liquefaction: shaky sediments. Exploratorium Teacher Institute. <https://www.youtube.com/watch?v=Kkgt-cPjBwA> (accessed 8 May 2020).

Murty, C. V. R., 2005. Earthquake Tip 30: What is important in foundations of earthquake-resistant Buildings? IITK-BMTPC "Learning earthquake design and construction", NICEE, India. <http://www.iitk.ac.in/nicee/EQTips/EQTip30.pdf> (accessed 5 May 2020).

Earthquake-safe Buildings

Article 3. Three Structural Systems to Resist Earthquakes

The buildings of any city are diverse. Some are low-rise while others are very tall, some are compact and others huge, like a shopping malls. Even though buildings appear radically different, there are only three common structural systems that can resist earthquake shaking. The three systems are shear walls, or structural walls; braced frames; and moment frames, as shown in Figure 1.

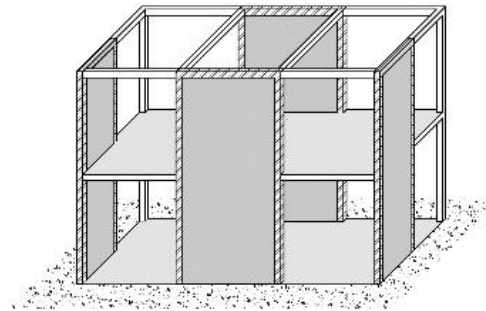

(a) Shear walls

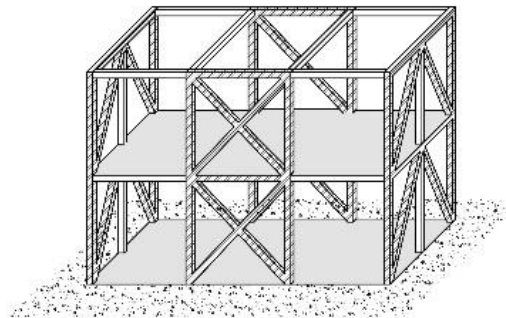

(b) Braced frames

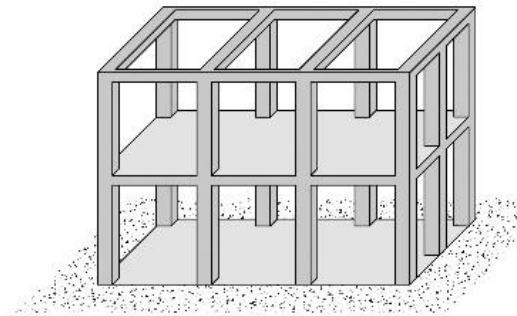

(c) Moment frames

Figure 1. The three common structural systems in order of their strength and ability to resist earthquakes (highest to lowest).

When architects and civil engineers design a new building, they choose one of the three systems to resist earthquake forces. Sometimes, two systems are chosen to resist shaking in the building, one in each direction (Figure 2). Provided that one of the three systems provides strength across and along the building, the building can resist shaking from any direction.

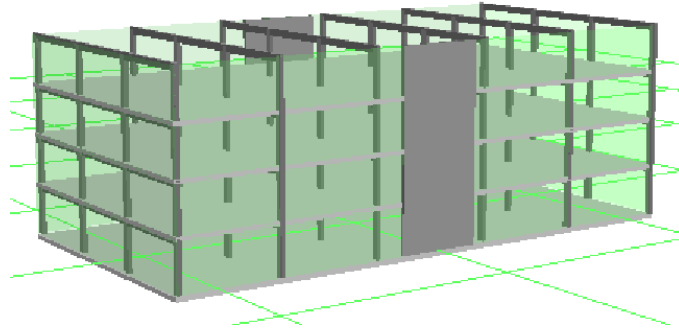

Figure 1. Six moment frames, each of three bays, resist shaking across the building, and two structural walls resist shaking in the direction along the length of the building. (The roof slab is not shown.)

Each system is vertical and should rise up the building from foundation to roof. The numbers of walls, braced frames or moment frames required depend on a city's seismic risk, the size of the building and its importance to the community.

Moment frames are a popular system (Figure 3). Their columns and beams resist earthquake shaking by being connected strongly (refer Article 6). Frames offer the greatest freedom for planning interior spaces and providing windows. Unfortunately, moment frames are usually more flexible in earthquakes than the other two systems. They sway further to-and-fro and are more prone to damage. They are also more difficult to design and build properly, and are sensitive to construction errors. As for their construction materials, they are usually built of reinforced concrete or structural steel. Wooden frames can be used for low-rise buildings.



Figure 2. The two four-bay moment frames resist earthquake forces acting along the building. Similar frames are expected to be on the other side of the building.

Braced frames contain diagonal members that form triangles with the beams and columns (Figure 4). They are fabricated from steel members and are most commonly found in low-rise construction, like warehouses. Welding quality can be a weakness in steel connections unless there is excellent quality assurance, and steel braces can buckle under large forces.



Figure 3. Steel braced frames resist earthquake forces acting across the building. Steel moment frames provide strength along the building.

Shear walls or structural walls are potentially the strongest structural system against earthquake shaking (Figure 5). Internationally, they have the best track record. The longer the walls and the more walls, the stronger the building. This means less to-and-fro shaking movements causing building damage. Reinforced concrete is the most common material for high-rise structural walls. Confined masonry walls (refer Article 4) are suitable for low-rise buildings. In some earthquake-prone countries, like the USA or New Zealand, low-rise wooden construction relies on plywood or gypsum plasterboard structural walls for earthquake resistance. Engineered wood products like cross-laminated timber are also emerging for use as shear walls in mid-rise buildings.



Figure 4. A reinforced concrete structural wall resists forces acting along the length of the building. There should be another wall on the other side of the building.

About this article series:

This is a series of articles about earthquakes, their effects on buildings, and how to ensure that buildings are safe against earthquakes. They are intended for potential owners of new houses and larger buildings and others involved in the building industry. The articles are written by Andrew Charleson and colleagues from the World Housing Encyclopedia (<http://www.world-housing.net/>) which is sponsored by the Earthquake Engineering Research Institute (<https://www.eeri.org/>) and the International Association of Earthquake Engineering (<http://www.iaee.or.jp/>).

References:

Braced Frame. Glossary for GEM Taxonomy. Global Earthquake Model. <https://taxonomy.openquake.org/terms/braced-frame-lfbr>.

Charleson, A. W., 2008. *Seismic design for architects – outwitting the quake*. Elsevier: Oxford. Chapter 4 “Vertical structure”, pp. 63-91.

Moment Frame. Glossary for GEM Taxonomy. Global Earthquake Model. <https://taxonomy.openquake.org/terms/moment-frame-lfm>.

Murty, C. V. R., 2005. *How do earthquakes affect reinforced concrete buildings – Earthquake Tip 17*. IITK-BMTPC “Learning earthquake design and construction”, NICEE, India. <http://www.iitk.ac.in/nicee/EQTips/EQTip17.pdf> (accessed 5 May 2020).

Murty, C. V. R., 2005. *Why are buildings with shear walls preferred in seismic regions?– Earthquake Tip 23*. IITK-BMTPC “Learning earthquake design and construction”, NICEE, India. <http://www.iitk.ac.in/nicee/EQTips/EQTip17.pdf> (accessed 5 May 2020).

Wall. Glossary for GEM Taxonomy. Global Earthquake Model. <https://taxonomy.openquake.org/index.php/terms/wall-lwal>.

Earthquake-safe Buildings

Article 4. Why Walls Are the Best Earthquake-resistant Structural Elements

As mentioned in Article 3, walls are one of the three common systems used in buildings to resist horizontal shaking. Walls are potentially the strongest of the three systems, the least flexible and the least sensitive to construction errors. They also have a very good track record based upon international observations of earthquake-damaged buildings (Figure 1). Although structural walls are not as prevalent in medium- to high-rise buildings as compared to moment frames, frames are far more prone to damage. For example, for this reason many of the buildings in Chile contain structural walls rather than column and beam frames. The walls have performed well in recent large earthquakes.



Figure 1. An earthquake damaged building. The strength and stiffness of the long white-colored masonry walls have prevented damaged. A more flexible structural system acting across the building has led to larger movement and damage to the front façade. It is temporarily covered with sheets of plywood.

Walls, therefore, are the best structural elements to resist earthquakes. But the choice of wall material depends on the height of the building. In low-rise buildings, like one- and two-story houses, confined masonry walls (Article 7) are the most suitable, considering construction aspects and cost (Figure 2). The confining reinforced concrete tie column and tie beam dimensions for these buildings are smaller than for similar buildings that use moment frames (Article 6). As noted above, walls lead to smaller to-and-fro movements. As a result, they and other building elements, like partitions, suffer less damage due to earthquake shaking. However, walls do restrict interior planning and natural light more than frames. The costs of their foundations may also be greater. These are their main disadvantages.

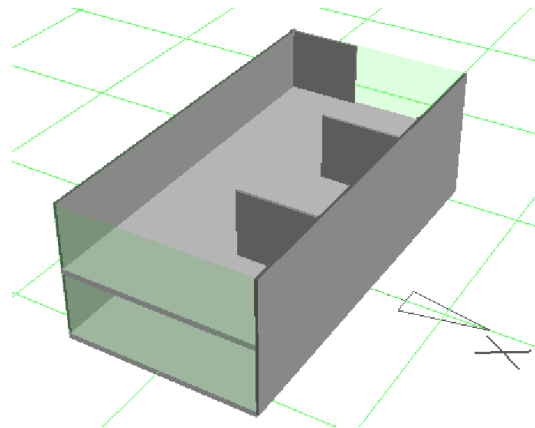

Figure 2. A two-story house with confined masonry walls and concrete roof slab (not shown). Two long boundary walls resist shaking in the direction of the building length. Three shorter walls resist sideways shaking (X-direction). Columns and partition walls are not shown.

Reinforced concrete walls are common in taller buildings of other earthquake-affected countries. These walls rise continuously from strong foundations, with or without piles and without large openings at the lower stories, to the roof (Figure 3). Each concrete floor slab as well as the roof needs a strong connection to the walls.



Figure 3. A building under construction. Most of the earthquake forces in both directions are resisted by reinforced concrete structural walls. In this case, some assistance is also provided by a perimeter steel moment frame.

To be safe, structural walls must have sufficient thickness and enough horizontal length. If walls are too thin, their ends buckle and are damaged during earthquake shaking. If too short (skinny), walls are too weak and flexible, and buildings may sway to-and-fro too far (Figure 4) and cause excessive damage. For low-rise masonry buildings, the number of walls required for shaking in both directions, wall lengths and thicknesses may be found from construction guidelines, such as by Meli (2011). Correct reinforcing steel details of wall construction is also important for ensuring safety in an earthquake (Carlevaro, 2018). For taller buildings, structural walls must be designed by qualified civil engineers.

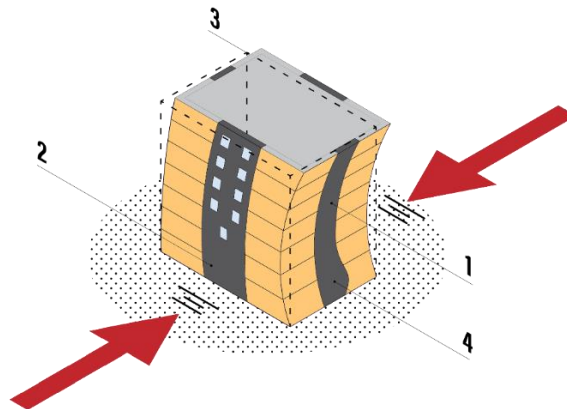

Figure 4. During an earthquake two slender walls (1) resist sideways shaking but allow too much movement. Also, they buckle at their base. Two longer walls (2) restrict movement in the other direction. The original position of the building is denoted by the dotted outline (3) and (4) shows the wall buckling at its base because it is too thin.

About this article series:

This is a series of articles about earthquakes, their effects on buildings, and how to ensure that buildings are safe against earthquakes. They are intended for potential owners of new houses and larger buildings and others involved in the building industry. The articles are written by Andrew Charleson and colleagues from the World Housing Encyclopedia (<http://www.world-housing.net/>) which is sponsored by the Earthquake Engineering Research Institute (<https://www.eeri.org/>) and the International Association of Earthquake Engineering (<http://www.iaee.or.jp/>).

References:

Carlevaro, N., Roux-Fouillet, G., and Schacher, T., 2018. Guide book for building earthquake-resistant houses in confined masonry. Guide book for technical training for earthquake-resistant construction of one to two-storey buildings in confined masonry. Swiss Agency for Development and Cooperation Humanitarian Aid and Earthquake Engineering Research Institute. http://www.world-housing.net/wp-content/uploads/2018/11/Guide-book-for-building-eq-re-houses-in-cm_version-1806.pdf (accessed December 2019).

Charleston, A. W., 2008. Seismic design for architects: outwitting the quake. Oxford, Elsevier. Chapter 5, pp. 66-76.

Meli, R., Brzev, S., Astroza, M., Boen, T., et al., 2011. Seismic design guide for low-rise confined masonry buildings. EERI and IAEE. <http://www.world-housing.net/wp-content/uploads/2011/08/ConfinedMasonryDesignGuide82011.pdf> (accessed April 2020).

Murty, C. V. R., 2005. *Why are buildings with shear walls preferred in seismic regions?– Earthquake Tip 23*. IITK-BMTPC “Learning earthquake design and construction”, NICEE, India. <http://www.iitk.ac.in/nicee/EQTips/EQTip17.pdf> (accessed 5 May 2020).

Earthquake-safe Buildings

Article 5. Are Walls in Buildings Helpful during Earthquakes?

All houses and buildings have walls. Walls protect and shelter us. Most walls in *Bandung* buildings are built from bricks or blocks, then plastered and painted. Walls are usually located around the perimeter of a building, but are also inside. Walls create the spaces we occupy and openings for doors and windows make spaces livable. Walls also support the roof.

Just like anyone, masonry walls have strengths and weaknesses. In fact, a wall has two areas of strength and one serious weakness. First, a wall is strong to support the weight of construction above it. It is also strong when resisting a horizontal force parallel to its length, say during an earthquake. This is especially so if the wall brickwork has been laid first, and only then 'practical' reinforced concrete tie columns and tie beams are cast. This safe type of construction, widely used in Indonesia, is called confined masonry. The vertical and horizontal reinforced concrete members confine the bricks, preventing them from falling out, and generally tie everything together (Figures 1 and 2). Brick walls without reinforcing like this are unsafe during earthquakes.

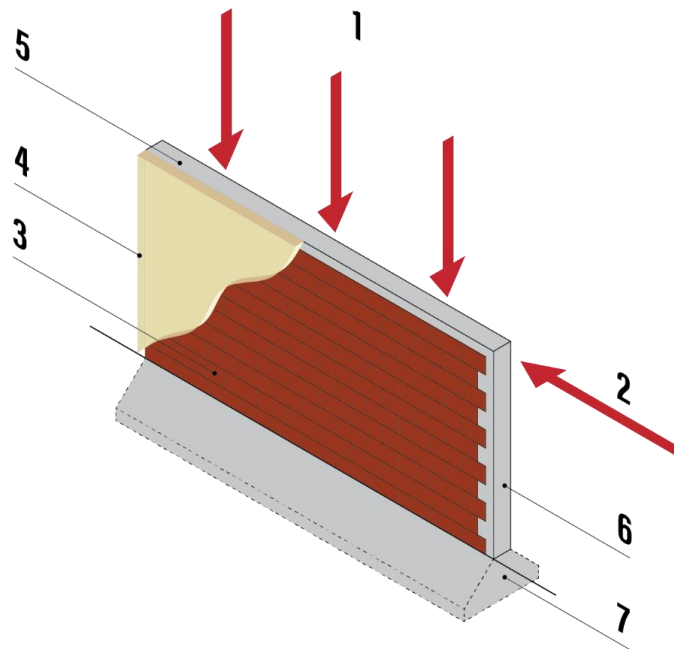

Figure 1. A wall is strong for downwards forces (1) and horizontal forces (from earthquakes) (2) parallel to its length. Masonry units or bricks (3) are plastered (4) and supported by a foundation (7). The masonry is confined by a tie beam (5) and practical or tie columns (6).



Figure 2. A confined masonry house under construction.

What about the weakness of walls? Where a wall is thin and not supported by side walls or a floor or roof, it is very weak against earthquake shaking at right angles to its length (Figure 3). Recall how difficult it is to build a model house from playing cards. A vertical card (wall) falls over unless it is supported by one or two cards at right angles to it. Try it for yourself!

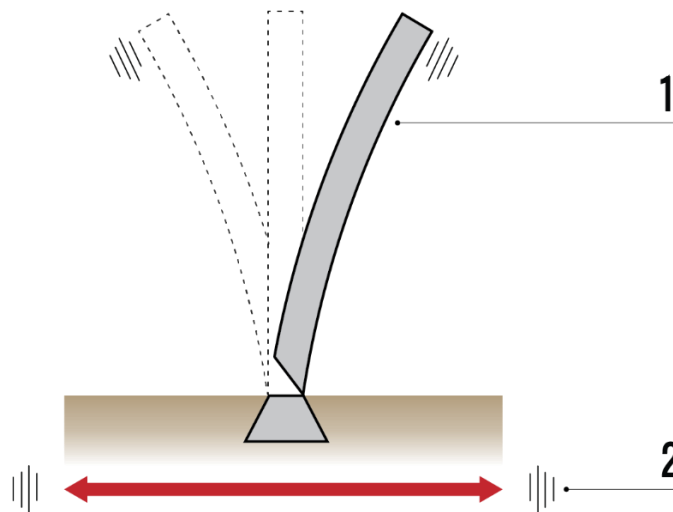

Figure 3. A wall shown in cross-section (1) is very weak against sideways forces from earthquake shaking (2).

Every wall needs sideways support to overcome its weakness, while simultaneously supporting other walls. In a real building we overcome the weakness of a wall against sideways forces from earthquakes (and wind) by other walls at right angles and tie beams. The tie beam running along the top of a vulnerable wall ties to similar beams running along walls that are oriented at right angles to it (Figure 4). Unless a wall is connected to other walls at right angles like this, it will probably collapse in an earthquake. The 'practical' columns embedded within most house walls and shown in Figure 1 are too weak on their own to provide support for walls.

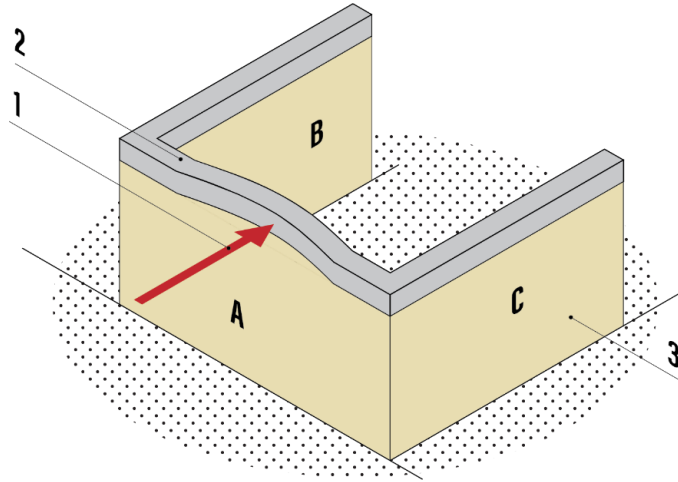

Figure 4. Part of a house without the roof. Wall A that experiences a sideways force from shaking (1) is supported mainly by the tie beam (2) that connects the top of wall A to walls B and C (3).

In larger buildings with reinforced concrete columns and beams, walls do not support the weight of the building. However, walls still need support to prevent them from falling sideways into or out of a building during earthquake shaking.

About this article series:

This is a series of articles about earthquakes, their effects on buildings, and how to ensure that buildings are safe against earthquakes. They are intended for potential owners of new houses and larger buildings and others involved in the building industry. The articles are written by Andrew Charleson and colleagues from the World Housing Encyclopedia (<http://www.world-housing.net/>) which is sponsored by the Earthquake Engineering Research Institute (<https://www.eeri.org/>) and the International Association of Earthquake Engineering (<http://www.iaee.or.jp/>).

References:

Carlevaro, N., Roux-Fouillet, G., and Schacher, T., 2018. Guide book for building earthquake-resistant houses in confined masonry. *Guide book for technical training for earthquake-resistant construction of one to two-storey buildings in confined masonry*. Swiss Agency for Development and Cooperation Humanitarian Aid and Earthquake Engineering Research Institute. http://www.world-housing.net/wp-content/uploads/2018/11/Guide-book-for-building-eq-re-houses-in-cm_version-1806.pdf (accessed December 2019).

Earthquake-safe Buildings

Article 6. How Do Buildings with Reinforced Concrete Columns and Beams Work in Earthquakes?

While low-rise buildings such as single or two-story houses rely on masonry or wood framed walls for support during earthquake shaking, many taller buildings rely on a framework of reinforced concrete columns and beams that support floor slabs. Such frameworks can also be constructed from steel members. These vertical and horizontal structural members work together to support a building's weight and to resist horizontal earthquake shaking.

The best way to appreciate a reinforced concrete framework and how it resists earthquakes is to see it in the nude! That is, to see the bare structure of a building before exterior and interior walls are constructed (Figure 1). Only four components are visible, the roof, floor slabs, columns and beams. Compared to walls that are relatively long horizontally, columns are very slender. They are the most critical structural members in a building. They support the entire weight of the building. During earthquakes columns need to bend and sway sideways without breaking as they resist horizontal forces (Figure 2).



Figure 1. These two buildings resist earthquakes through the strength of their columns and beams. Walls and cladding are yet to be constructed.

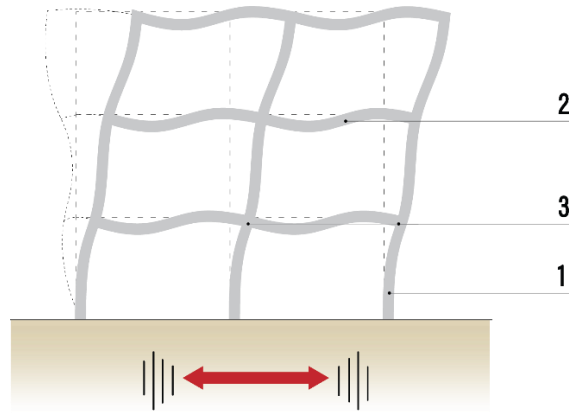

Figure 2. A column (1) and beam (2) frame building moves sideways during an earthquake. Note that both columns and beams bend. They are connected at strong joints where they meet (3).

However, the columns can't do all this on their own. They need beams to help them out. The beams are deeper than the floor slabs they support and are strongly connected to the columns. Special reinforcing steel embedded in the concrete is required in these joint regions. Strong column-beam joints mean that when the columns bend, the beams also bend. This makes the building stronger overall, far less flexible or floppy, and less prone to damage.

Since columns are the most critical structural elements they must be protected. If they get seriously damaged then the whole building is at risk of collapse. Engineers use two strategies to protect columns. First, columns must be large and strong. Slender columns just bend and break during earthquake shaking, so columns must be substantial in size. As well as being large enough, columns need plenty of vertical reinforcing steel and horizontal ties up their height (Figure 3). The ties prevent columns from breaking as they bend sideways. Columns should be considerably wider and thicker than any masonry walls meeting them. They must be sized in accordance with the engineer's calculations.



Figure 3. Column reinforcement is visible before the concrete is cast. The reinforcement consists of vertical bars that resist bending, and horizontal ties that stop the column concrete from disintegrating and dislodging.

The second strategy to protect columns is to design them stronger than the beams. This means that during strong earthquake shaking the intentionally slightly weaker beams suffer sacrificial, but non-critical damage and in the process protect the columns.

These two strategies mean that earthquake-safe structural frameworks usually have relatively large columns, slightly smaller beams and strong beam-column joints.

About this article series:

This is a series of articles about earthquakes, their effects on buildings, and how to ensure that buildings are safe against earthquakes. They are intended for potential owners of new houses and larger buildings and others involved in the building industry. The articles are written by Andrew Charleson and colleagues from the World Housing Encyclopedia (<http://www.world-housing.net/>) which is sponsored by the Earthquake Engineering Research Institute (<https://www.eeri.org/>) and the International Association of Earthquake Engineering (<http://www.iaee.or.jp/>).

References:

Murty, C. V. R., et al., 2006. At risk: the seismic performance of RC frame buildings with masonry infill walls. California, World Housing Encyclopedia. http://www.world-housing.net/wp-content/uploads/2011/05/RCFrame_Tutorial_English_Murty.pdf (accessed 8 June 2020).

Earthquake-safe Buildings

Article 7. Principles for Earthquake-safe Masonry Buildings

The previous Article 5 provided basic information about masonry walls, the most common earthquake-resisting components of low-rise buildings in Indonesia. It discussed how walls are strong in the direction of their lengths but vulnerable to sideways shaking. Masonry walls, using good quality materials, should be built as confined masonry walls. This means every brick panel is confined by a reinforced concrete 'practical' or tie column at each end and a reinforced concrete tie beam. The beam is cast on the wall at eaves level and with the floor slab at every story.

How then do we incorporate these walls into a building, like a two-story house? First, we must remember that the walls are to protect the building against earthquake shaking. Then we need to apply the following four principles:

1. Each house needs a minimum of two strong walls parallel to the building length and two walls at right-angles. Earthquake shaking comes from all directions so every building needs strength both sideways and lengthways (Figure 1). Although all masonry walls should be of confined masonry construction, strong walls do not have large openings that weaken it by preventing diagonal forces forming within it (Figure 2). Further, the thickness of masonry plus plaster should be sufficient for the wall height, and finally, each strong wall should be longer than half the story height. Refer to Meli (2011) and others for more detailed information.

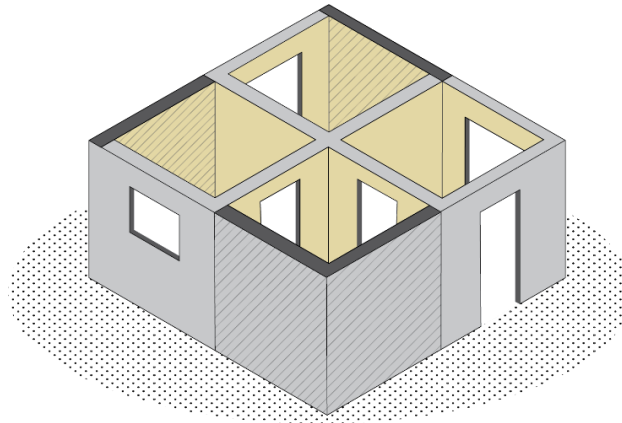

Figure 1. In this simple house two strong walls (shown shaded and without large openings) resist earthquake shaking across and along the building.

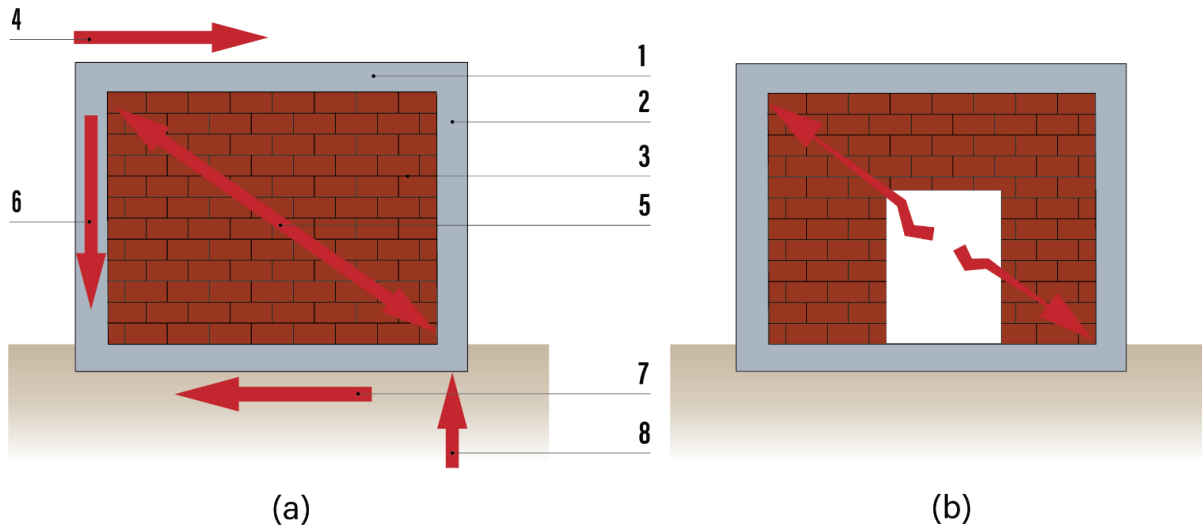

Figure 2. A strong confined masonry wall with tie beams (1), columns (2) and masonry (3). When an earthquake strikes (4) it is resisted by diagonal compression in the wall (5) and tension in a tie column (6). The horizontal earthquake force is resisted by the ground (7) and the vertical force also by the ground (8). In (b) the wall has an opening that prevents the formation of diagonal lines of force and that greatly weakens the wall.

2. The strong walls should be regularly distributed throughout the building in both directions (Figure 3). Walls running in the same direction spaced well apart prevent the building twisting during an earthquake. It is of critical importance to have sufficient walls, in terms of length and thickness, in each direction. What is “sufficient” depends on the building size and quality of bricks or blocks.

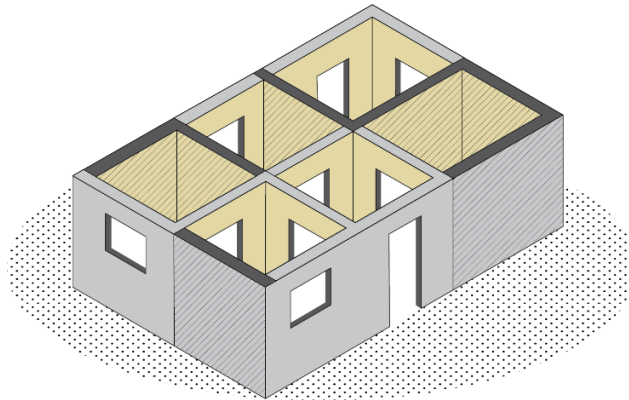

Figure 3. Strong walls are well distributed throughout the building. Four strong walls resist shaking across the house and three resist shaking along its length. All walls must be tied together by tie beams (not shown).

3. Tie beams must tie the tops of walls together. Tie beams not only confine the masonry panels but also tie the construction elements together to stop them from being torn apart.
4. Strong walls of any building should be vertical and continuous from the foundation to the roof tie beam. This means, for example, that in a two-story house a strong wall on the upper floor must be directly above a similar strong wall at ground level.

About this article series:

This is a series of articles about earthquakes, their effects on buildings, and how to ensure that buildings are safe against earthquakes. They are intended for potential owners of new houses and larger buildings and others involved in the building industry. The articles are written by Andrew Charleson and colleagues from the World Housing Encyclopedia (<http://www.world-housing.net/>) which is sponsored by the Earthquake Engineering Research Institute (<https://www.eeri.org/>) and the International Association of Earthquake Engineering (<http://www.iaee.or.jp/>).

References:

Boen, T., et al., 2009. Buku saku Persyaratan pokok rumah yang lebih aman. PU and JICA.

https://www.jica.go.jp/indonesia/indonesian/office/topics/pdf/buku_saku_0.pdf (accessed 11 April 2020).

Carlevaro, N., Roux-Fouillet, G., and Schacher, T., 2018. Guide book for building earthquake-resistant houses in confined masonry. Swiss Agency for Development and Cooperation Humanitarian Aid and EERI. http://www.world-housing.net/wp-content/uploads/2018/11/Guide-book-for-building-eq-re-houses-in-cm_version-1806.pdf (accessed December 2019).

Meli, R., Brzev, S., Astroza, M., Boen, T., et al., 2011. Seismic design guide for low-rise confined masonry buildings. EERI and IAEE. <http://www.world-housing.net/wp-content/uploads/2011/08/ConfinedMasonryDesignGuide82011.pdf> (accessed April 2020).

Public Works Department, 2016. Izin mendirikan bangunan Gedung, No. 05/PRT/M/2016.

<http://ciptakarya.pu.go.id/pbl/index.php/preview/55/permen-pupr-no-05-tahun-2016-tentang-izin-mendirikan-bangunan-gedung> (accessed 11 April 2020).

For other free and downloadable detailed information, visit <https://confinedmasonry.org/>.

Earthquake-safe Buildings

Article 8. Tying Parts of Buildings Together to Resist Earthquakes

Buildings consist of many different parts. Some parts, like floors, roof, columns, beams and walls are parts of the main structure. Others, like partition walls, cladding walls, and stairs are not load-bearing. They are necessary to make the building livable, but the building wouldn't fall down without them.

During an earthquake, a building including all its parts, gets severely shaken. The most damaging shaking are to-and-fro horizontal motions in random directions. Earthquake shaking has the potential to shake a building to pieces. If not properly designed and constructed a building can be torn apart into many pieces and collapse. This horrifying scenario has been observed after earthquakes in many countries.

It is possible to prevent such severe damage. What is required is to tie parts of the main structure together at each floor level and at roof level. Vertical elements like walls, also need to be tied at each level by ring or tie beams, which are usually made of reinforced concrete. This technique is similar to wrapping strong belts or ties around each level of a building to prevent its parts bulging and falling apart during earthquake shaking (Figure 1).



Figure 1. A damaged building during an earthquake can be held together at floor and roof level by tie or ring beams which function like strong belts.

Fortunately, where the floors of a building are of reinforced concrete, they are usually sufficient to tie the building together at those levels. Of course, the main purpose of a floor is to create a surface to walk and store things on. But when horizontal shaking occurs, a floor ties a building together at that level (Figure. 2). A floor forces everything to move together - as a whole, and stops parts being shaken loose and falling off the building. It may not even be necessary to add extra reinforcing steel to a concrete slab in order to achieve this tying action.



Figure 2. The reinforced concrete floors of this building tie the beams and columns together and force all these parts to move together horizontally during an earthquake.

It's more difficult to tie a level of a building together where there's no floor or roof slab, or where masonry walls are used in conjunction with wooden floors. In these cases, ring or tie beams do the job (Figure 3). They create a horizontal framework within and around the perimeter of a building to tie everything together. They stop walls and columns being shaken loose towards or away from each other. They prevent parts of the roof sliding off their supports and falling down. A framework of ring beams is more flexible than a concrete slab but has proved to function like that imaginary perimeter belt.



Figure 3. Walls of a simple building are not prevented from falling by columns alone. Roof-level ring or tie beams can tie the building together. (From Guide book for building earthquake resistant houses in confined masonry (World Housing Encyclopedia, 2018).

In summary, each level of a building, from the foundation until roof level needs to be strongly tied together. Floor slabs, roof slab or ring beams are required.

About this article series:

This is a series of articles about earthquakes, their effects on buildings, and how to ensure that buildings are safe against earthquakes. They are intended for potential owners of new houses and larger buildings and others involved in the building industry. The articles are written by Andrew Charleson and colleagues from the World Housing Encyclopedia (<http://www.world-housing.net/>) which is sponsored by the Earthquake Engineering Research Institute (<https://www.eeri.org/>) and the International Association of Earthquake Engineering (<http://www.iaee.or.jp/>).

References:

Bothara, J., and Brzev, S., 2011. A Tutorial: Improving the Seismic Performance of Stone Masonry Buildings. Earthquake Engineering Research Institute, Oakland, California, U.S.A., Publication WHE-2011-01, 78 pp. www.world-housing.net/tutorials/stone-tutorials (accessed 10 July 2020).

Charleson, A. W., 2008. Seismic design for architects – outwitting the quake. Elsevier: Oxford. Chapter 4 “Horizontal structure”, pp. 49-61.

Murty, C. V. R., 2005. Why are horizontal bands necessary in masonry buildings – Earthquake Tip 14. IITK-BMTPC “Learning earthquake design and construction”, NICEE, India. <http://www.iitk.ac.in/nicee/EQTips/EQTip14.pdf> (accessed 5 May 2020).

Swiss Agency for Development and Cooperation SDC, 2018. Guidebook for building earthquake-resistant houses in confined masonry. http://www.world-housing.net/wp-content/uploads/2018/11/Guide-book-for-building-eq-re-houses-in-cm_version-1806.pdf (accessed 5 May 2020).

Earthquake-safe Buildings

Article 9. Local Wisdom and Building Safety in Earthquakes

In this country of Indonesia, as in other countries, post-earthquake observations sometimes reveal that traditional buildings are safer than newer buildings. Traditional buildings incorporate local wisdom in the choice of materials, their shapes, structural systems and connections between structural members.

The question we contemporary designers and builders need to ask is this: What are the principles derived from local wisdom that we should reintroduce into new buildings to improve earthquake safety? Before answering this question, we need to recall the features of traditional construction relevant to their performance in earthquakes. Briefly, traditional construction usually features:

- wooden or bamboo structure for floors, roof and walls;
- light-weight construction, possibly with the exception of a tiled roof;
- relatively flexible connections between columns and beams; and
- flexible or intentionally weak connections between a building and its foundations.

Buildings incorporating local wisdom are therefore lightweight and flexible. They sway to-and-fro considerably during an earthquake. Also, if weakly connected to their foundations, such buildings can be considered partially isolated from shaking ground. According to current earthquake design practice these characteristics may be desirable. For example, because earthquake forces occurring in a building are proportional to its weight, construction materials should be as lightweight as possible. A lighter building is safer than a similar heavy building.

Flexibility can be advantageous unless a building is sited on soft soil. But a disadvantage of flexibility is greater sideways movement during an earthquake (Figures 1 and 2). This means more damage. Generally, flexibility should be avoided. Flexible connections to foundations can be advantageous in reducing earthquake forces, but only if buildings can't fall off their foundations. The modern system of base-isolation (Article 23) that is recommended for important buildings like hospitals incorporates sideways flexibility at foundation level.



Figure 1. A very flexible building during horizontal shaking. Traditional construction materials and methods are incorporated into a new traditional Indonesian building.



Figure 2. Traditional construction in another region of Indonesia results in another building type that is flexible.

Unfortunately, opportunities to incorporate local wisdom into new buildings are very limited. The main reason is that compared to the past, modern buildings are so different. To begin with, most new buildings use heavy materials, like masonry and reinforced concrete (Figure 3). Buildings are also designed to be less flexible, in order to reduce movements, damage and repair costs. And finally, it is difficult and costly to make connections between a building and its foundations flexible.



Figure 3. Conventional heavy construction using reinforced concrete and masonry - in this case, confined masonry construction.

In theory, some principles suggested by local wisdom can improve earthquake safety, but because of how today's buildings are constructed so differently, most principles can't be applied directly. The one exception is to build with lighter, rather than heavier, materials.

About this article series:

This is a series of articles about earthquakes, their effects on buildings, and how to ensure that buildings are safe against earthquakes. They are intended for potential owners of new houses and larger buildings and others involved in the building industry. The articles are written by Andrew Charleson and colleagues from the World Housing Encyclopedia (<http://www.world-housing.net/>) which is sponsored by the Earthquake Engineering Research Institute (<https://www.eeri.org/>) and the International Association of Earthquake Engineering (<http://www.iaee.or.jp/>).

Earthquake-safe Buildings

Article 10. Infill Walls and How They Affect Buildings during Earthquakes

Infill walls are masonry walls filling the area between columns and the underside of beams above. Infills are constructed after the reinforced concrete columns and beams are cast. Infills are common in buildings that rely on structural frameworks of columns and beams for earthquake resistance. Reinforced concrete frames with infills may appear similar to confined masonry construction (Article 7), but these are two totally different systems.

Infill walls are constructed from fired clay or concrete masonry units (bricks/blocks) laid in cement or cement:lime mortar. Even with small windows, infill walls are usually stiffer and stronger against earthquake horizontal movement than the primary structure. Sometimes infills reduce earthquake damage, yet often they make it worse.

When a column and beam framework experiences earthquake shaking all the members bend and the structure moves sideways (Figure 1a). However, if frame openings are infilled, the infill restricts bending of the columns and beams. The infill experiences large diagonal compression forces. Diagonal cracks also form. The compression forces apply pressure against the tops and bottoms of the columns, often causing damage to these areas (Fig. 1b). Diagonal cracks increase the vulnerability of infills to shaking perpendicular to their lengths. Sections of, or entire infills can fall out of buildings (Figure 2). Search online for “masonry infill earthquake damage” images for further information.

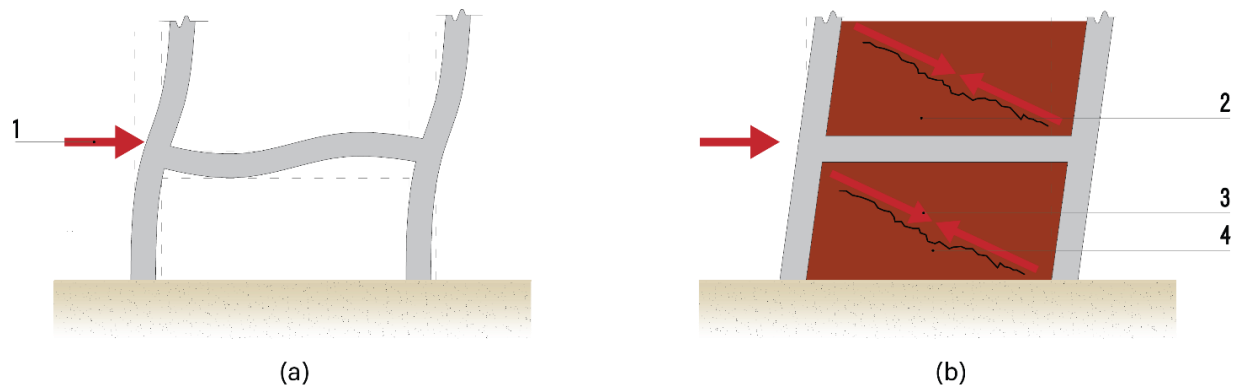

Figure 1. (a) An elevation of a bare or open column and beam frame that is bending sideways in an earthquake (1). (b) shows how the infill (2) prevents bending, experiences a diagonal compression strut (3) and diagonal cracking (4).



Figure 2. Earthquake-damaged infill walls, some of which have fallen out of the building.

Infills can improve the earthquake-safety of a building, but only if the following conditions are met. The infills acting along the building, must be symmetrical in plan, and must be continuous from the ground floor to roof level. Also, they

must be strengthened against shaking perpendicular to their lengths as discussed next. The same requirements must apply to infills acting across the building. Finally, the columns and beams, as well as the infills themselves, need to be designed by qualified civil engineers.

Where these conditions aren't met, infills experience damage and cause serious damage to columns adjacent to them. Design options for earthquake -safe construction are limited. By far the best option is to substitute masonry infill with an incombustible lighter-weight and more flexible material, like cement board. Alternatively, use glazing between infills and columns with movement clearance provided along the sides of all glass panes. Loss of life and damage to the primary structure is thereby prevented. Another option where solid walls are required, is to separate infills from their surrounding columns and beams using narrow gaps filled with compressible material (Figure 3). The gaps allow the columns and beams to bend, but reinforcement or steel brackets are required to stabilize the walls against perpendicular shaking. Another option is to place the walls in front of or behind the columns, allowing columns and beams to bend (Figures 4 and 5).

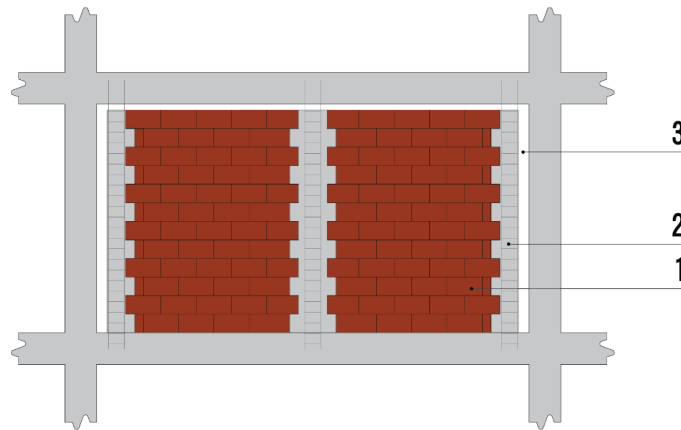

Figure 3. A masonry infill wall (1), protected from shaking perpendicular to its length by intermediate, or 'practical columns' (2), and separated from columns and beam by narrow gaps (3) subsequently infilled with soft material and covered with a flashing.



Figure 4. An example of an intermediate column to stabilize a masonry wall (S.Brzev).

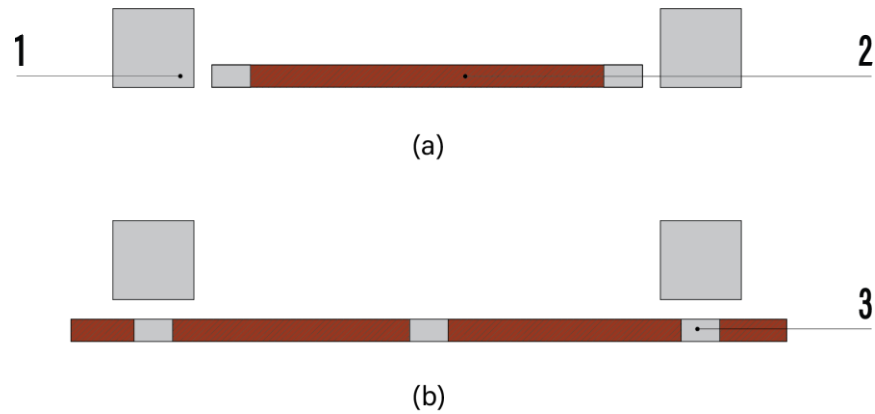

Figure 5. (a) Is a plan view of columns (1) either side of a separated infill (2) whose small columns at each end provide stability. In (b) the masonry wall with stabilizing columns (3) has been shifted from the structural columns so as not to impede their bending.

About this article series:

This is a series of articles about earthquakes, their effects on buildings, and how to ensure that buildings are safe against earthquakes. They are intended for potential owners of new houses and larger buildings and others involved in the building industry. The articles are written by Andrew Charleson and colleagues from the World Housing Encyclopedia (<http://www.world-housing.net/>) which is sponsored by the Earthquake Engineering Research Institute (<https://www.eeri.org/>) and the International Association of Earthquake Engineering (<http://www.iaee.or.jp/>).

References:

Charleson, A. W., 2008. Seismic design for architects: outwitting the quake. Oxford, Elsevier, pp. 159-168.

Infilled frame. Glossary for GEM Taxonomy. Global Earthquake Model. <https://taxonomy.openquake.org/terms/infilled-frame>.

Murty, C. V. R., et al., 2006. At risk: the seismic performance of RC frame buildings with masonry infill walls. California, World Housing Encyclopedia. http://www.world-housing.net/wp-content/uploads/2011/05/RCFrame_Tutorial_English_Murty.pdf (accessed 8 June 2020).

Semnani, S. J., Rodgers, J. E., and Burton, H. V., 2014. Seismic Design Guidance for New Reinforced Concrete Framed Infill Buildings. Geohazards International. https://4649393f-bdef-4011-b1b6-9925d550a425.filesusr.com/ugd/08dab1_5710341c7b304eef9d79bfd50efe839a.pdf (accessed 8 June 2020).

Earthquake-safe Buildings

Article 11. A Common Structural Weakness to Avoid: Soft Story

Compare the two buildings in Figure 1. The columns and beams of both buildings are strong enough to carry their weight, a downwards force. But how do the buildings compare when sideways forces occur? Winds cause sideways forces, but the most severe forces occur during an earthquake when the ground shakes buildings to-and-fro in every horizontal direction.

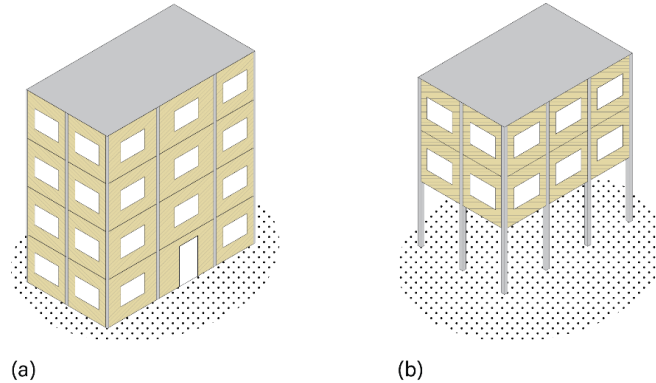

Figure 1. In building (a) exterior and interior infill and partition walls are on every floor, but in (b) these walls are absent in the ground floor. The ground floor is open.

The first building (Figure 1a) is relatively strong against horizontal forces. At each story, a combination of reinforced concrete columns and beams, together with infill and partition walls, work together to resist horizontal earthquake forces. Every story appears to have a similar strength. However, in total contrast, the second building (Figure 1b) lacks any strengthening walls on the ground floor. Perhaps this floor is used for car parking. This story, then, is far weaker than the stories above. Ideally, the lowest or the lower stories of a building are stronger than those above. Consider the shape of a tree trunk (Figure 2). Most trunks are strongest at ground level because that's where stresses are highest during strong winds. Buildings should follow the same principle and be strongest at ground level.



Figure 2. Most tree trunks are strongest at ground level.

When the second building (Figure 1b) is shaken by an earthquake, damage occurs at the weakest area. In this case, it is the ground floor columns (Figure 3). The columns bend sideways, and in the process are damaged. Often the extent of the damage means that the columns can no longer support the building's weight. The columns break and the building collapses. The lowest story is totally crushed. Maybe some stories above also suffer the same damage. Loss of life is inevitable.

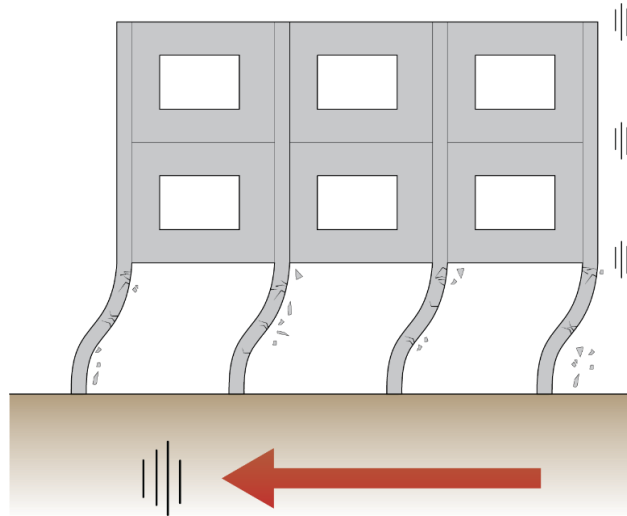

Figure 3. The columns in a soft story bend excessively and suffer serious damage.

Soft or weak stories almost always occur during damaging earthquakes (Figure 4). Readers can search the internet for “soft story building” and see many other images. However, the good news is that this type of damage is preventable. Provided engineers and architects follow the local design codes and best-practice guidelines during the design and construction of new buildings, soft stories are avoidable. For more information, see “References”.



Figure 4. This soft story building lost its ground floor during a moderate earthquake (N. Vesho).

What about an existing building with a soft story (Figure 5)? It is possible to improve its earthquake performance. Some cities around the world have begun earthquake retrofitting programs. However, retrofitting may involve inserting new structural systems, such as braced frames or structural walls. It is often difficult for the contractor, inconvenient for occupants and expensive. It is far preferable to avoid soft stories in new construction by good collaboration between architect and civil engineer, and then the civil engineer's careful design incurs little, if any, additional cost.



Figure 5. A typical soft story building where the ground floor is the weakest.

About this article series:

This is a series of articles about earthquakes, their effects on buildings, and how to ensure that buildings are safe against earthquakes. They are intended for potential owners of new houses and larger buildings and others involved in the building industry. The articles are written by Andrew Charleson and colleagues from the World Housing Encyclopedia (<http://www.world-housing.net/>) which is sponsored by the Earthquake Engineering Research Institute (<https://www.eeri.org/>) and the International Association of Earthquake Engineering (<http://www.iaee.or.jp/>).

References:

Charleson, A. W., 2008. Seismic design for architects: outwitting the quake. Oxford, Elsevier, pp. 144-148.

Murty, C. V. R., 2005. Why are Open-Ground Storey Buildings Vulnerable in Earthquakes? Earthquake Tip 21. IITK-BMTPC “Learning earthquake design and construction”, NICEE, India. <http://www.iitk.ac.in/nicee/EQTips/EQTip17.pdf> (accessed 5 May 2020).

Soft Storey. Glossary for GEM Taxonomy. Global Earthquake Model. <https://taxonomy.openquake.org/terms/soft-storey-sos#>.

Earthquake-safe Buildings

Article 12. A Common Structural Weakness to Avoid: A Discontinuous Wall

For buildings that use walls to resist horizontal earthquake shaking, it is vitally important that the walls rise vertically from the foundations of the building and continue uninterrupted to roof level. This principle, that walls should be continuous, applies regardless of the material of construction, be it reinforced concrete or masonry. It also applies even if the walls are infill walls and are not primary structural elements. The strength and stiffness of infill walls mean that to a large extent they act as structural members even if not intended by the designers.

There are two main types of discontinuous wall layouts. The first is where a column and beam framework has all but one story infilled (Figure 1a). Usually the open story is at the ground floor. This arrangement most likely will lead to a soft story during a damaging earthquake. The danger of a soft story is discussed in the previous article, Article 11, of this series.

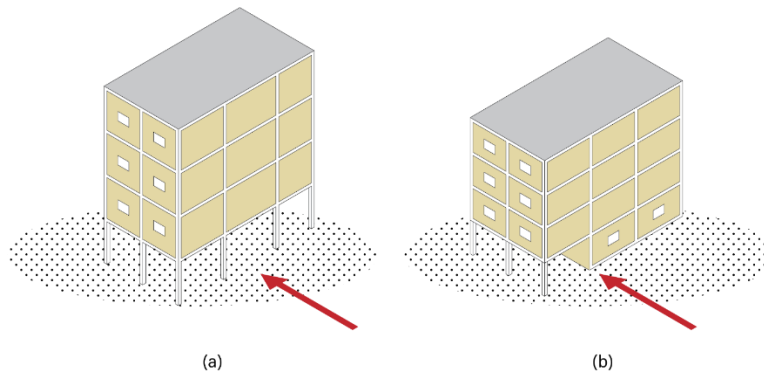

Figure 1. Two types of discontinuous walls. In (a) there are no infills at the ground floor, and in (b) the ground floor infill wall is off-set relative to the wall above.

The second type of discontinuous walls occurs where walls are off-set in plan (Figure 1b). There may be infill walls in every story, but at the ground level the wall is set back inside the building compared to the walls above. The upper walls therefore project out beyond the lowest wall (Figure 2). An off-set creates a serious local weakness in a wall, especially when it tries to resist horizontal earthquake forces. An off-set wall is like a tree with a kink in it (Figure 3). A strong wind will probably break the tree at the kink. Forces within any structure don't like changing direction abruptly. So, how to overcome this problem?



Figure 2. Buildings with off-set infill walls line this street.



Figure 3. A kink in a tree trunk introduces a local weakness.

The best approach is to ensure an off-set wall is not structural. Other structural elements within the building, like beam and column frames must be designed to resist earthquake forces in the direction parallel to the wall. At the design stage, the masonry of any proposed offset wall should be replaced by non-combustible light-weight material, like cement board or glazing. These are too weak to act as structural elements during an earthquake. Alternatively, separate any off-set masonry wall from its structural frame to prevent the wall functioning as structure (see Article 10).

About this article series:

This is a series of articles about earthquakes, their effects on buildings, and how to ensure that buildings are safe against earthquakes. They are intended for potential owners of new houses and larger buildings and others involved in the building industry. The articles are written by Andrew Charleson and colleagues from the World Housing Encyclopedia (<http://www.world-housing.net/>) which is sponsored by the Earthquake Engineering Research Institute (<https://www.eeri.org/>) and the International Association of Earthquake Engineering (<http://www.iaee.or.jp/>).

References:

Charleson, A. W., 2008. Seismic design for architects: outwitting the quake. Oxford, Elsevier, pp. 151-153.

Earthquake-safe Buildings

Article 13. A Common Structural Weakness to Avoid: Short Column

When it comes to carrying the weight of a building, a long or high column, especially if small in cross-section, can be problematic. It is prone to buckling. However, from the perspective of designing earthquake-safe buildings, short columns can cause a critical structural weakness. Although not as dangerous as a soft story, short columns perform very poorly during an earthquake.

Short columns are most commonly formed where infill walls in a column and beam building are only partially high (Figures 1 and 2). An alternative and more descriptive term for 'short column' is 'captive column'. This is because, during an earthquake with its horizontal to-and-fro shaking, the lower length of the column is held captive by partial-height infill walls. They prevent the column from bending sideways like a normal column does. So, all the horizontal movement occurs in the short length of column that is unrestrained by the infill wall. This is the problem!

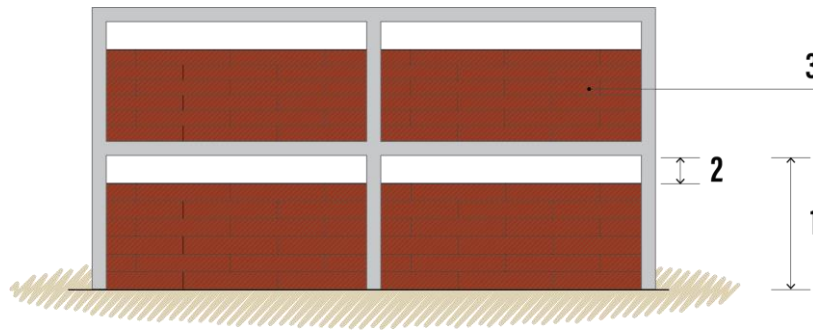

Figure 1. Elevation of a building with short columns. Rather than being able to bend over their full height (1), bending is confined to the height of the windows (2) due to the influence of the infill walls (3).



Figure 2. Normal height columns have been shortened from the perspective of resisting horizontal forces by partial-height infill walls.

Normal columns unaffected by infill walls are able to bend sideways in a flexible manner during an earthquake. In the process of bending, columns develop narrow cracks that are not serious. However, if a column is partially constrained by infill walls, the movement that normally occurs over the whole story-height of a column concentrates in the 'short column' above the top of the infill wall (Figure 3). Not only does such horizontal movement over a short vertical distance cause heavy structural damage, but a short column is too rigid to bend. Rather, it just breaks in a shearing action. It

snaps like a carrot. Diagonal cracks form in the column and crushed concrete falls from the damaged area (Figure 4). The building drops and eventually requires demolition. Many images of this type of damage can be viewed in an online search for “short column effect”.

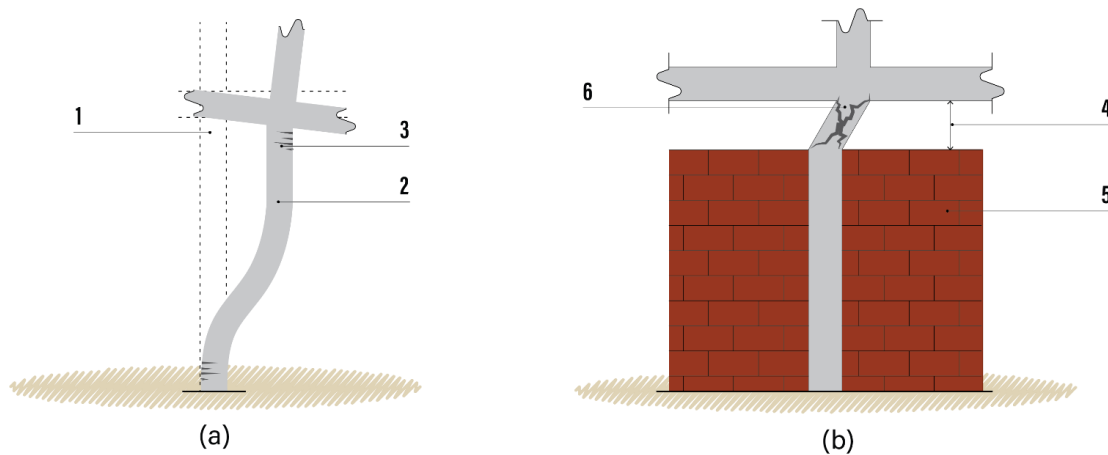

Figure 3. (a) During an earthquake (1) a normal height column bends (2) as it moves horizontally. In the process it cracks (3) but can still remain strong. In (b) an upper window (4) and masonry infills (5) cause serious diagonal cracks in the short column that lead to the column disintegrating.



Figure 4. Earthquake-damaged short columns.

There are several methods to avoid short columns. In the first, the lengths of windows are reduced so that their ends are well away from the tops of the columns. Secondly, construct infill walls from incombustible light-weight material, like cement board. It is too weak to constrain the lower part of a column which can then bend normally. Finally, if masonry partial-height infill walls are required, then they need to be physically separated from the columns by narrow vertical gaps. These gaps need treatment to ensure weather tightness. Steel brackets are required to stabilize the infill walls so that during earthquake shaking they don't fall out of or into the building (Figure 5).

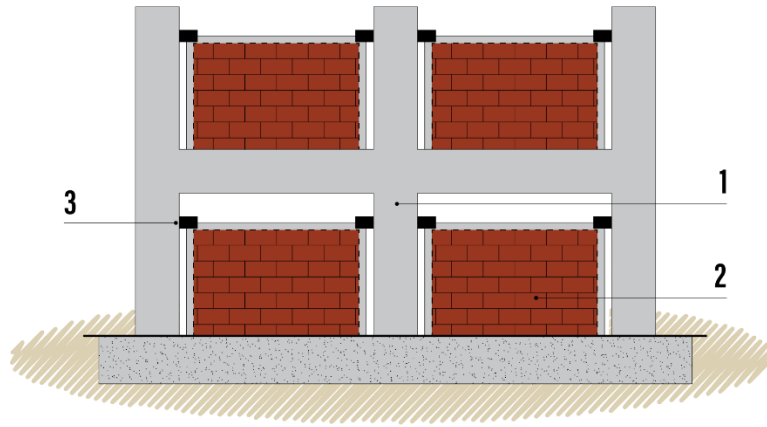

Figure 5. A reinforced concrete frame with potential short columns (1) and masonry infill walls (2) confined by tie columns and tie beams. The infills are separated from the frame by vertical separation gaps but restrained at their top corners by steel brackets bolted to the columns (3). The brackets allow movement between columns and walls parallel to the walls, but prevent the walls from falling from the building during an earthquake.

About this article series:

This is a series of articles about earthquakes, their effects on buildings, and how to ensure that buildings are safe against earthquakes. They are intended for potential owners of new houses and larger buildings and others involved in the building industry. The articles are written by Andrew Charleson and colleagues from the World Housing Encyclopedia (<http://www.world-housing.net/>) which is sponsored by the Earthquake Engineering Research Institute (<https://www.eeri.org/>) and the International Association of Earthquake Engineering (<http://www.iaee.or.jp/>).

References:

Charleson, A. W., 2008. Seismic design for architects: outwitting the quake. Oxford, Elsevier, pp. 148-151.

Murty, C. V. R., 2005. Why are Short Columns more Damaged During Earthquakes? Earthquake Tip 22. IITK-BMTPC "Learning earthquake design and construction", NICEE, India. <http://www.iitk.ac.in/nicee/EQTips/EQTip17.pdf> (accessed 5 May 2020).

Short Column. Glossary for GEM Taxonomy. Global Earthquake Model. <https://taxonomy.openquake.org/terms/short-column-shc>.

Video: Captive column by Cale Ash, Academy of Earthquake Safety. <https://www.youtube.com/watch?v=kRG3XwOvzuo>.

Earthquake-safe Buildings

Article 14. Preventing a Building from Twisting during Earthquake

To some extent all buildings twist during an earthquake. Twisting means that as you look down on a building from above it rotates slightly. Not only will earthquake shaking itself cause buildings to twist, but twisting becomes more severe if the structure of a building is not symmetrical compared to the overall building area (Figure 1a).

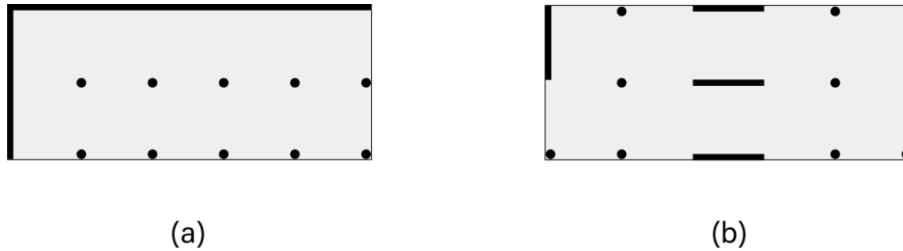

Figure 1. Two ground floor plans of buildings. In (a) earthquake force in each direction is resisted by a wall on the side of the building that is not symmetrical compared to the area of the building. This building will twist badly during an earthquake. In (b) the walls in each direction are located symmetrically. Twisting will be minimal.

To understand the problem, try this experiment. Use your body to appreciate what a building experiences. So, first, stand upright and hold your arms out horizontally. Then, rotate your head and shoulders, first in one direction and then in the other (Figure 2). You can feel your body twisting, experiencing torsion.

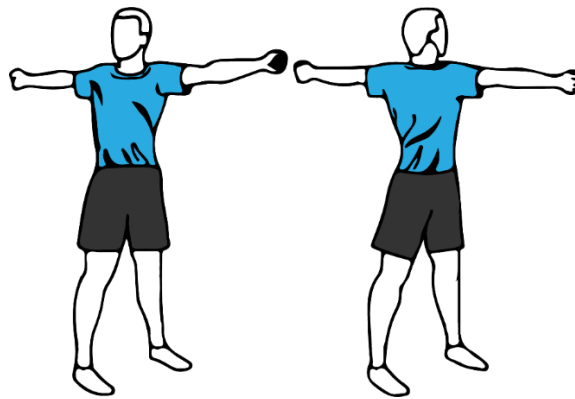

Figure 2. Twisting your body to experience torsion.

When you twist your body, you notice how much further your hands move compared to, say, your ears. Next, imagine your body is a structural core or tower supporting a much larger building (Figure 3) whose length extends to the ends of your fingers. Imagine several columns along the length of each arm supporting the floors of your 'building'. Now when you and your building twist, the columns furthest away from the core move sideways a great deal. And when they have to move sideways excessively, they are seriously damaged in the process and perhaps no longer capable of supporting the weight of the building.



Figure 3. An example of a reinforced concrete core in a building under construction.

Designers, civil engineers and architects have two ways to control torsion and reduce column damage. First, they locate the load-bearing walls or other vertical structure like column and beam frames reasonably symmetrically over the floor plan (Figure 1b). Secondly, in both horizontal directions, along and across a building, they provide at least two strong vertical structural elements well separated from each other. If these two elements are located on the perimeter of the building, at both ends and both sides, they become most effective in controlling torsion. They prevent too much sideways movement of the columns and subsequent serious damage (Figure 4).

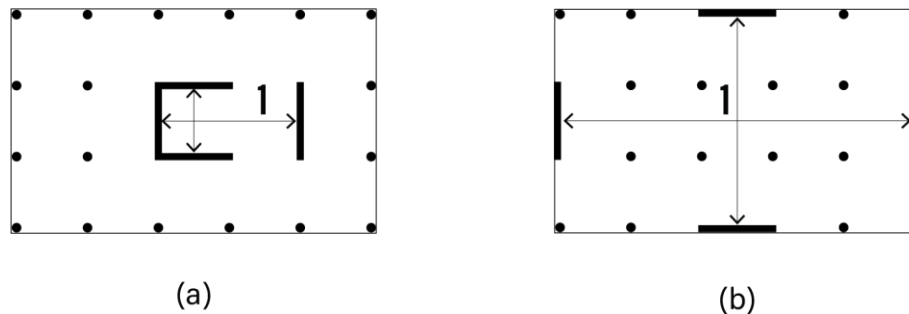

Figure 1. Two ground floor plans of buildings. In (a) earthquake forces in each direction, across and along the building, are resisted by two walls placed reasonably symmetrically. The walls are separated (1) but not by much. However, in (b) the walls acting in each direction have maximum separation (1) and so provide the best control of torsion.

About this article series:

This is a series of articles about earthquakes, their effects on buildings, and how to ensure that buildings are safe against earthquakes. They are intended for potential owners of new houses and larger buildings and others involved in the building industry. The articles are written by Andrew Charleson and colleagues from the World Housing Encyclopedia (<http://www.world-housing.net/>) which is sponsored by the Earthquake Engineering Research Institute (<https://www.eeri.org/>) and the International Association of Earthquake Engineering (<http://www.iaee.or.jp/>).

References:

Charleson, A. W., 2008. Seismic design for architects: outwitting the quake. Oxford, Elsevier, pp. 128-132.

Murty, C. V. R., 2005. How Buildings Twist During Earthquakes?: Earthquake Tip 7. IITK-BMTPC “Learning earthquake design and construction”, NICEE, India. <http://www.iitk.ac.in/nicee/EQTips/EQTip07.pdf> (accessed 5 May 2020).

Torsion eccentricity. Glossary for GEM Taxonomy. Global Earthquake Model. <https://taxonomy.openquake.org/terms/torsion-eccentricity-tor>.

Earthquake-safe Buildings

Article 15. Why Buildings Pound Each Other during Earthquakes

Have you ever travelled on crowded public transport, perhaps a bus, or a train? You might be standing close to others but not touching them. However, when the bus changes speed or direction, everyone moves, causing you to bump into the passenger next to you.

Something like this happens during earthquakes. When the ground shakes, buildings amplify the shaking. But buildings don't shake together, or in-phase. Each building is different, and moves differently during an earthquake. Each building has a different frequencies of vibration at which it resonates. To-and-fro movements intensify differently for each building, increasing up each building's height.

If buildings are constructed too close together or against one another, when the ground shakes, each building vibrates differently. The buildings pound their neighbours, sometimes causing serious damage (Figures 1 and 2). An online search for images of "earthquake building pounding", reveals many instances of pounding damage during various earthquakes around the world.

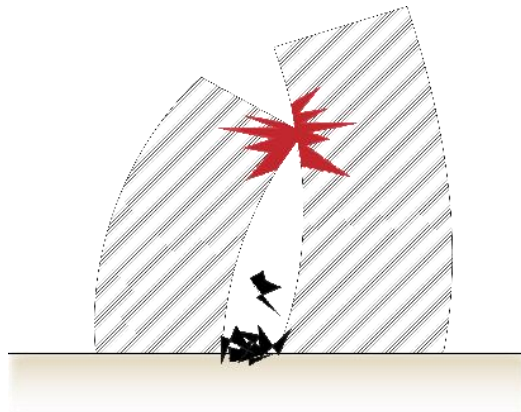

Figure 1. Two buildings with an insufficiently wide seismic gap pounding each other during an earthquake.



Figure 2. Two buildings have pounded each other with one far more seriously damaged than the other.

The solution to preventing pounding between new buildings is straightforward – build back inside your boundaries, except along a street frontage. The gaps along the sides and back of your building need to be wide enough so that during an earthquake your building doesn't move over its boundary and crash into your neighbours' buildings (Figure 3). Provision of these gaps is standard practice in many cities worldwide.

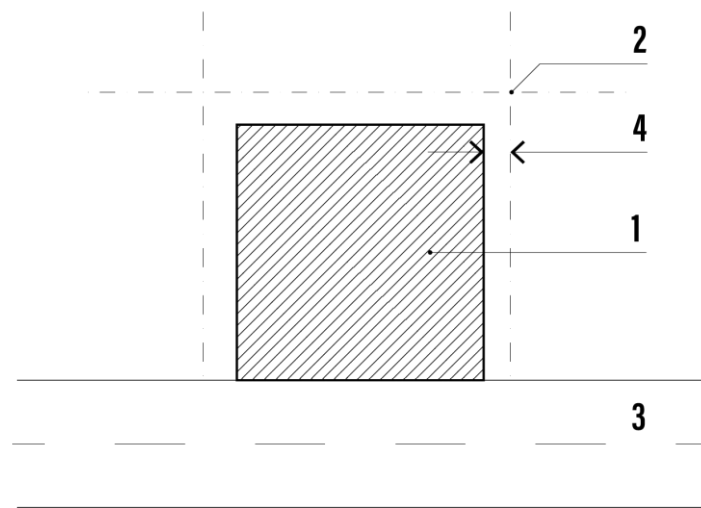

Figure 3. A plan of a building (1) within its boundaries (2) and on a street (3). On three sides the building is built back from the boundaries by the width of a seismic gap (4).

How wide do these gaps, usually referred to as “seismic separation gaps”, need to be? It depends on the building’s height and its flexibility. For the most flexible building allowed by earthquake codes the gap to the boundary is about 2% of the building height. For a four-story building this is about 240 mm. A narrower seismic gap is feasible if the civil engineer designs a stiffer building; for example, with larger columns and beams, or longer structural walls. When adjacent buildings are closeby, gaps are covered by flexible flashings (Figures 4 and 5).



Figure 4. Two buildings separated by a seismic gap covered by a flexible flashing.



Figure 5. A close-up of the flashing covering the seismic gap.

It is very difficult to prevent pounding between existing buildings with narrow separation gaps or none at all during a strong earthquake. If the floor levels of adjacent buildings align, the pounding of floor slabs against each other is less serious than where floors of adjacent buildings are not at the same level. In this case, the floor slabs of one building can seriously damage adjacent columns of the other building. One solution is to provide new 'back-up' columns in case the outer and more vulnerable columns are damaged.

About this article series:

This is a series of articles about earthquakes, their effects on buildings, and how to ensure that buildings are safe against earthquakes. They are intended for potential owners of new houses and larger buildings and others involved in the building industry. The articles are written by Andrew Charleson and colleagues from the World Housing Encyclopedia (<http://www.world-housing.net/>) which is sponsored by the Earthquake Engineering Research Institute (<https://www.eeri.org/>) and the International Association of Earthquake Engineering (<http://www.iaee.or.jp/>).

References:

Charleson, A. W., 2008. Seismic design for architects: outwitting the quake. Oxford, Elsevier, pp. 137-139.

Pounding potential. Glossary for GEM Taxonomy. Global Earthquake Model.
<https://taxonomy.openquake.org/terms/pounding-potential-pop>.

Earthquake-safe Buildings

Article 16. Construction Codes and Standards

The purpose of construction codes and standards is to ensure, first of all, that your building is safe. Secondly, that it is free of defects like sagging beams during its lifetime, while using materials efficiently. Codes and standards are usually produced by teams of experts from universities, engineering practice, government departments and contractors. Members of these teams draw upon their own research and experience (Figure 1). In addition, they review the latest developments overseas. Where appropriate to local conditions these developments are included in new or updated codes (or standards). When published, a code represents the state-of-the-art recommendations for safe, long-lasting and economic construction.



Figure 1. Full-scale reinforced concrete columns and beams being tested in a laboratory.

Like every industry, however, the construction industry experiences change. New materials, new construction techniques, and new design approaches are constantly developed (Figure 2). Change and innovation arises from contractors and researchers. This means codes need to be updated regularly. If not, they lead to both unsafe and uneconomic buildings.



Figure 2. This building contains innovative examples of the use of precast concrete.

Codes set best practice standards of construction. Their rules must be followed for your own sake, assuming you are the building owner or occupant, and for the sake of the wider community. Failure to adhere to certain standards causes

serious consequences. Consider, for example, what could happen in another situation where standards are not followed. Imagine a doctor examining you when you are ill. If the doctor takes shortcuts during the examination to save time, like not measuring blood pressure or requesting an X-ray, the diagnosis might be incorrect. In that case, the prescribed medicines will be ineffective and your illness will worsen. Codes and standards protect you.

Following codes is most important where situations are complex and personal knowledge and experience is limited. Designing and constructing a building to resist earthquakes is such an example. Almost no civil engineers, architects and builders have personally witnessed what happens to buildings during a large earthquake – how they suffer increasing damage until eventually collapsing. Neither have most building professionals personally observed scientific laboratory tests of building elements, like columns and beams, being subject to experimental earthquake movements. Codes compensate for the lack of personal experience, knowledge and wisdom regarding earthquakes. Following codes is the only way to safe construction.

Codes provide guidance at all stages of building design and construction (Figure 3). Civil engineers and architects must adhere to certain standards during design and construction phases. Builders must ensure materials and methods of construction also follow standards. Following standards is for your benefit. If mistakes are made or shortcuts taken, then your building is unlikely to be safe in earthquakes. Codes and standards must always be followed.



Figure 3. The foundations of a building under construction. Engineers have followed codes to determine the amount of reinforcing steel and its correct location.

About this article series:

This is a series of articles about earthquakes, their effects on buildings, and how to ensure that buildings are safe against earthquakes. They are intended for potential owners of new houses and larger buildings and others involved in the building industry. The articles are written by Andrew Charleson and colleagues from the World Housing Encyclopedia (<http://www.world-housing.net/>) which is sponsored by the Earthquake Engineering Research Institute (<https://www.eeri.org/>) and the International Association of Earthquake Engineering (<http://www.iaee.or.jp/>).

Earthquake-safe Buildings

Article 17. What to Look for in Building Regulations

Building regulations (e.g., building codes and standards) are the rules for building. They protect us and others. They support a safe and healthy built environment. They are intended to ensure safe buildings for living, working, shopping and worshipping in. Regulations reflect that buildings can be designed to be safe for earthquakes and contain rules to achieve that goal.

So, what should we expect in building regulations? What might make them more successful in achieving safe buildings? Here are five suggestions:

1. **Reflect our societal situation and expectations:** Regulations need to be appropriate for society as a whole, its cultural and economic situation and the expectations of its citizens (Figure 1). The levels of imposed standards may not be as high as those in high-income countries but, as agreed by a wide range of stakeholders, standards should be appropriate to local conditions and affordable. Codes are also needed that address locally prevalent construction practice where professionals are not involved, and traditional construction, including incremental construction (Figure 2).



Figure 1. People expect to live in buildings that are safe in earthquakes.



Figure 2. Codes and their implementation are necessary to improve the earthquake-safety of this type of housing.

2. **Fair to all parties:** It is important that regulations are fair to everyone. They mustn't favor any one party outside of or within the building industry, like building material manufacturers who might benefit from specific regulations.
3. **Easy to access and clear to understand:** Building regulations need to be easy to access for the public and building industry stakeholders, like civil engineers, architects and builders. Accessible documents are also required for training purposes. Regulations can be made available on-line. They also have to be clear. Readers must be able to understand and interpret the requirements of regulations. The goal is openness and transparency.
4. **Responsive to changing circumstances and new information:** Although the building industry changes more slowly than some industries, such as IT, building regulations still need to be kept up-to-date. Otherwise, they stifle innovation and reduce opportunities for more affordable and efficient building practices. Also, building practices that recent research deems unsafe need improving. Building regulations need to reflect current knowledge, building industry competence and practice (Figure 3).



Figure 3. Building regulations need to specify safe yet practical ways of using new materials, such as these light-weight blocks.

5. **Part of wider regulatory processes:** Building regulations need legal and administrative backup. Uptake of regulations require both education and enforcement. Education of all stakeholders regarding earthquake-safe buildings needs input from education providers at every level in the building industry as well as professional societies. Building departments can help, but their primary role is to enforce regulations in a cost-effective, efficient and transparent manner.

About this article series:

This is a series of articles about earthquakes, their effects on buildings, and how to ensure that buildings are safe against earthquakes. They are intended for potential owners of new houses and larger buildings and others involved in the building industry. The articles are written by Andrew Charleson and colleagues from the World Housing Encyclopedia (<http://www.world-housing.net/>) which is sponsored by the Earthquake Engineering Research Institute (<https://www.eeri.org/>) and the International Association of Earthquake Engineering (<http://www.iaee.or.jp/>).

References:

Hoover, C. A. and Greene, M. eds, 1996. Construction quality, Education, and Seismic Safety. EERI, Oakland, U.S.A., 68pp.

Moullier, T., 2015. Building regulation for resilience: managing risks for safer cities. Word Bank Group and GFDRR, Washington, U.S.A. 136 pp. <https://www.preventionweb.net/publications/view/48493> (accessed 23 April 2020).

Earthquake-safe Buildings

Article 18. What to Expect from a Building Designed according to Codes

For a building to be safe in earthquakes it must be designed and built according to local codes. If not, then the building could be severely damaged or collapse in a moderate to large earthquake. However, even if a building complies fully with building codes it may still suffer serious damage. The reasons explained below dispel the belief that a code-complying building is earthquake-proof.

The first reason that a code-complying building will suffer damage in a large earthquake is that codes set minimum standards. If a building meets these standards it is considered safe, but it's definitely not earthquake-proof. Code writers believe that society can't afford to aim too high when providing earthquake protection. Therefore, a building isn't designed for the worst-case scenario because that has such a low chance of occurring during a building's lifetime. Rather, a building is designed for a smaller earthquake that typically has a ten percent chance of happening during a fifty-year period. Therefore, at present, codes mainly aim to save lives and reduce injuries, rather than protect the building itself. This means that during a large earthquake a code-complying building should not collapse, but will suffer serious damage which may or may not be economically repaired.

Secondly, in order to reduce the additional cost of constructing very strong buildings that won't get damaged in an earthquake, codes permit engineers to design for a just a fraction of the likely earthquake forces. This means that although damage to columns, beams and walls is inevitable, they are designed to not suddenly break and collapse. Engineers talk about designing "structural fuses", especially in beams (Figure 1). Just like fuses in electrical circuits protect sensitive electronic components, structural fuses at non-critical locations like at the end of beams, protect the more critical structural members, like columns. If structures of buildings are designed to avoid damage, typically they need to be up to five times stronger. This means columns and beams that are considerably larger than usual.

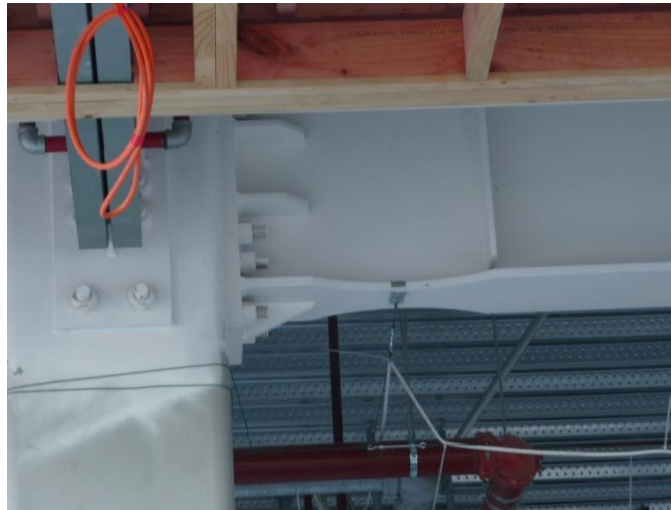

Figure 1. A building under construction with a column to the left and a steel beam connected to it. Note how the bottom plate (flange) of the beam near the column has been reduced in size. This area of deliberate weakening will be where a structural fuse will form in large earthquake. The steel in this region will stretch but not break.

Finally, a code-compliant building will suffer damage to cladding and partition walls, as well as to objects inside it, including mechanical equipment. During an earthquake, the floors and roof shake to-and-fro. These movements damage walls of plastered brick unless the walls have been very carefully designed, and also throw contents such as appliances and small items about (Figure 2).



Figure 2. An example of an earthquake damaged building where the infill walls have not been carefully designed to allow for forces and movements during an earthquake.

Codes try to strike a balance between the chances of a large earthquake occurring and the cost and other implications of designing for it. Codes specify minimum standards based on the building type. Hospitals must be designed to a higher standard than office buildings, for example. Given that codes specify minimum standards, a client can request a building be designed for enhanced performance. This could entail stronger and usually larger structure, or include special earthquake-resistant systems like base isolation (See Article 23). This technology, which has been incorporated into several buildings in Indonesia (Figures 3 and 4), is increasingly used in key buildings, like hospitals. It's a little more expensive but it's the only way to ensure such buildings are operational immediately after an earthquake and to insure against serious damage.



Figure 3. The base-isolated Ibis Hotel, Padang, Indonesia.



Figure 4. A circular rubber bearing containing many thin steel plates is located between the bottom of every column and its foundation to isolate the building from horizontal earthquake shaking.

About this article series:

This is a series of articles about earthquakes, their effects on buildings, and how to ensure that buildings are safe against earthquakes. They are intended for potential owners of new houses and larger buildings and others involved in the building industry. The articles are written by Andrew Charleson and colleagues from the World Housing Encyclopedia (<http://www.world-housing.net/>) which is sponsored by the Earthquake Engineering Research Institute (<https://www.eeri.org/>) and the International Association of Earthquake Engineering (<http://www.iaee.or.jp/>).

Earthquake-safe Buildings

Article 19. Importance of Checks during the Design of Buildings

People make mistakes. Most mistakes don't have serious consequences, but some do. Mistakes arise from many sources. They may be unintentional, like from a lack of care or concentration, or perhaps due to a lack of understanding. Some mistakes are intentional. People take shortcuts, don't follow plans or use inferior materials for financial gain. In the building industry mistakes can cost lives, especially during a damaging earthquake. A mistake made during the design process or during construction may not show up right away. But that defect may make the difference between a building remaining standing or collapsing during an earthquake (Figure 1).



Figure 1. Severe damage during an earthquake could occur if several reinforcing bars are missing from this reinforced concrete wall.

Some industries, in an attempt to reduce mistakes and increase safety, implement a system of checks. Airlines are a good example. Read the job description of a co-pilot and you see that checking is a significant part of the job. There are so many aspects of flying that need to be checked. If one aspect, say fuel requirements, is missed, the result can be catastrophic. Checklists are a crucial tool to ensure safety.

None of us like to have our work checked by others but this process is necessary, especially where mistakes can be dangerous. The design and construction of buildings is such an area. While it is relatively straight forward for a civil engineer to design a building to resist ordinary day-to-day forces, it is more difficult to design for movements during a large earthquake. A higher level of knowledge, understanding and experience is required and mistakes are more likely. Some form of checking, independent of the original designer is needed. Calculations, plans and specifications need checking to ensure they comply with local codes and standards (Figure 2).



Figure 2. During both design and construction these reinforced concrete walls were checked by engineers to ensure the structural design was sound and that construction was in accordance with the plans.

Ask your civil engineer what checks have been done. Has the work been checked independently by a qualified person in the same firm, or even better, by an engineer in another firm? If not, it should be, even though you will be charged for it. After checking, the construction documents are ready for a building permit application. Even if the Building Department doesn't do a technical check for safety before they issue a building permit, you can be reasonably confident of an earthquake-safe building provided the construction documents are followed on site.

About this article series:

This is a series of articles about earthquakes, their effects on buildings, and how to ensure that buildings are safe against earthquakes. They are intended for potential owners of new houses and larger buildings and others involved in the building industry. The articles are written by Andrew Charleson and colleagues from the World Housing Encyclopedia (<http://www.world-housing.net/>) which is sponsored by the Earthquake Engineering Research Institute (<https://www.eeri.org/>) and the International Association of Earthquake Engineering (<http://www.iaee.or.jp/>).

Earthquake-safe Buildings

Article 20. Importance of Checks during the Construction of Buildings

Article 19 outlined the need for an independent check of design calculations, plans and specifications before applying for a building permit, and definitely before commencing construction. A check gives the client confidence that local codes and standards have been followed and therefore the building is more likely to be earthquake-safe.

The next challenge is to arrange checks during construction. Like any of us, builders make accidental mistakes. Some also choose not to follow plans and specifications. They might omit reinforcing bars, bend them incorrectly, use too little cement in concrete or use poor quality bricks or blocks (Figure 1). Without checks, even a newly constructed building can be unsafe in earthquakes. There are many examples of very poor and unsafe construction (Figure 2). However, if a builder does follow the plans and specifications, a building is expected to remain safe during an earthquake for which it was designed.



Figure 1. A reinforcing bar is being tested to check it is up to standard.



Figure 2. The reinforcement of this column does not comply in numerous ways with the local codes and standards. During a moderate to large earthquake, it will be seriously damaged.

Your Building Department might have some requirements for quality assurance during construction. If so, follow those. If not, request that the civil engineer who designed the building supervise or observe its construction. Usually this will mean visiting the site regularly and especially before important activities are undertaken (Figure 3). For example, the reinforcing steel in columns should be checked before formwork hides the reinforcing bars and concrete is placed. Ask your engineer what he or she recommends in order that at the end of the project a statement can be signed to the effect that construction followed the plans and specifications.



Figure 3. An engineer needs to regularly visit construction sites like this to ensure construction is in accordance with the plans and specifications.

Some people may try to save money by not having any construction quality assurance. In these cases, mistakes and unauthorized changes are not detected. Details that are vital for earthquake safety might be built wrongly or even not built at all. Why put yourself and others at risk during an earthquake due to poor construction? It's not worth it!

About this article series:

This is a series of articles about earthquakes, their effects on buildings, and how to ensure that buildings are safe against earthquakes. They are intended for potential owners of new houses and larger buildings and others involved in the building industry. The articles are written by Andrew Charleson and colleagues from the World Housing Encyclopedia (<http://www.world-housing.net/>) which is sponsored by the Earthquake Engineering Research Institute (<https://www.eeri.org/>) and the International Association of Earthquake Engineering (<http://www.iaee.or.jp/>).

Earthquake-safe Buildings

Article 21. Preventing Damage to Non-structural Components

Most of these articles focus on ensuring that structures of buildings protect inhabitants during earthquakes. The aim is to avoid serious structural damage. If this goal is achieved, then lives are saved. It may also be technically and economically feasible to repair the structure post-earthquake. But what about damage to the rest of the building?

In terms of cost, main structure represents a modest percentage of the overall cost of a building. Typically, approximately 70% of a building's cost arises from parts other than structure. These are usually referred to as "non-structural components", such as chimneys, roof coverings (e.g., tiles), cladding, glazing, partitions, ceilings, mechanical and electrical systems, and so on. And we shouldn't forget the building contents, which may be very expensive. Not only do all these non-structural elements represent a huge financial investment, but during an earthquake, many are hazardous.

There are two causes of damage to non-structural components. The first is due to the sideways horizontal movement of the structure. Secondly, these components or elements are damaged by the accelerations from the earthquake shaking. See images by searching "nonstructural earthquake damage" online.

Sideways movements that occur during earthquakes are likely to damage elements like masonry cladding and partition walls. When an upper floor of a building moves horizontally further than the floor beneath, we expect damage to these elements (Figure 1). After all, stiff and brittle walls are incompatible with relatively flexible structural frameworks. Damage to elements such as walls can be reduced by either making them flexible (dry framing), or separating them from the columns and floor above. Careful architectural detailing is required.

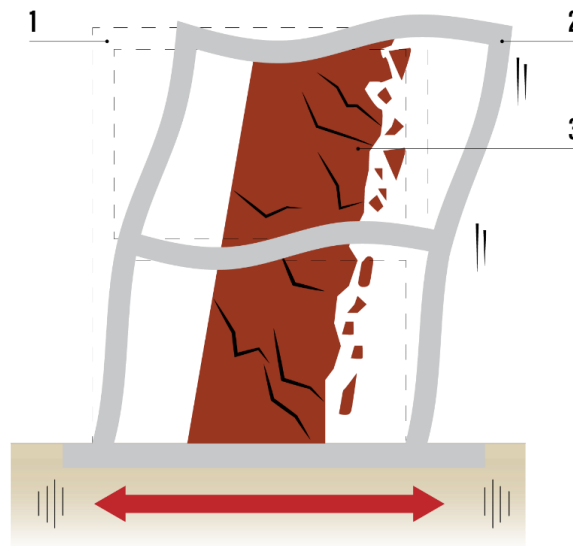

Figure 1. A structural frame before (1) and during an earthquake (2). Partitions (3) attached to floors above and below are damaged by horizontal movement due to the frame swaying.

Most other non-structural elements are damaged by earthquake accelerations. Intense shaking can break elements, shake them loose from their fixings so they fall over (Figures 2-4). Unrestrained building contents are flung around, causing injury and breakage. The lesson learned from previous earthquakes is that non-structural elements should be restrained. All items, including water tanks and mechanical and electrical equipment must be restrained (Figure 5). Otherwise, during shaking they will slide or overturn, often causing far more damage than they themselves sustain.

Refer to the document FEMA E-74 for examples of typical restraint methods. Many methods of restraining equipment are relatively cheap and are a wise investment by preventing damage during an earthquake.

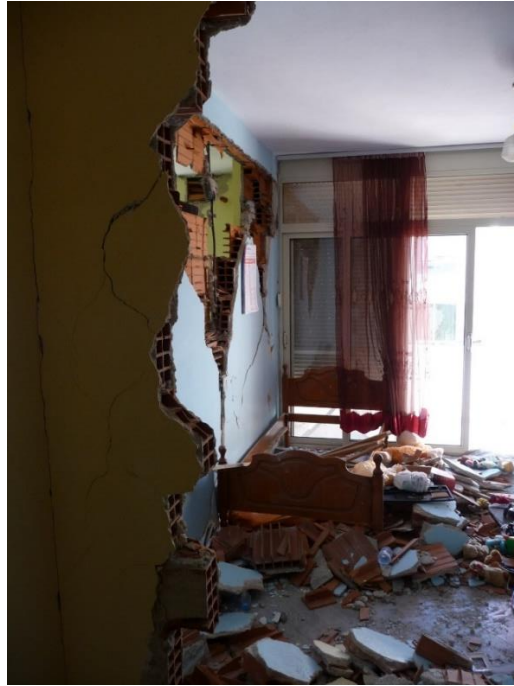

Figure 2. Walls damaged by earthquake shaking pose risk to life.



Figure 3. A brick chimney has broken off at roof level and fallen. Most of the remaining chimney is damaged (N. Allaf).



Figure 4. An earthquake has destroyed most of the brick cladding and glazing of this building.

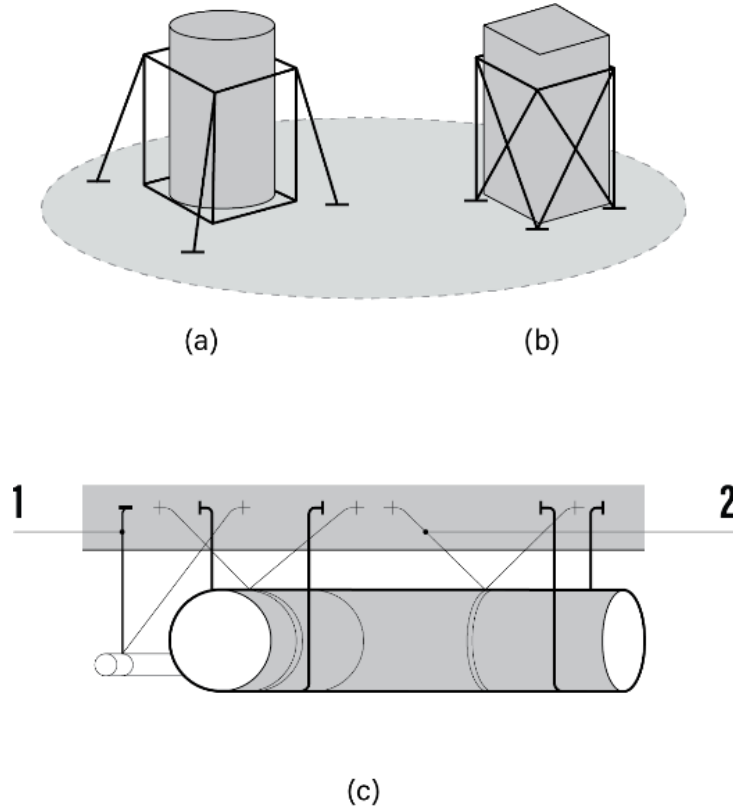

Figure 5. Tanks (a) and mechanical equipment (b) should be braced against earthquake. Also, in (c) pipework hangers (1) and ducting are braced (2).

About this article series:

This is a series of articles about earthquakes, their effects on buildings, and how to ensure that buildings are safe against earthquakes. They are intended for potential owners of new houses and larger buildings and others involved in the building industry. The articles are written by Andrew Charleson and colleagues from the World Housing Encyclopedia (<http://www.world-housing.net/>) which is sponsored by the Earthquake Engineering Research Institute (<https://www.eeri.org/>) and the International Association of Earthquake Engineering (<http://www.iaee.or.jp/>).

References:

Charleson, A. W., 2008. Seismic design for architects: outwitting the quake. Oxford, Elsevier, pp. 173-186.

FEMA, 2012. Reducing the Risks of Nonstructural Earthquake Damage—A Practical Guide (FEMA E-74) https://www.fema.gov/media-library-data/1398197749343-db3ae43ef771e639c16636a48209926e/FEMA_E-74_Reducing_the_Risks_of_Nonstructural_Earthquake_Damage.pdf.

Murty, C. V. R., 2005. How can Non-structural Elements be protected against Earthquakes? Earthquake Tip 27. IITK-BMTPC “Learning earthquake design and construction”, NICEE, India. <http://www.iitk.ac.in/nicee/EQTips/EQTip27.pdf> (accessed 5 May 2020).

Nonstructural. Mitigation Center. Earthquake Engineering Research Institute. <https://mitigation.eeri.org/category/structures/non-structural-abc-testing>.

Earthquake-safe Buildings

Article 22. Retrofitting Buildings against Earthquake

Retrofitting is the process of improving the earthquake performance of existing buildings that are considered unsafe. It is rather like how people with serious medical conditions undergo surgery to prolong their lives. Indeed, some retrofit projects have been described as seismic surgery.

There are many reasons buildings are retrofitted in earthquake-prone regions. In most cases, building regulations require action, such as retrofitting, to buildings assessed as being dangerous in earthquakes. The intention is to improve the resilience of cities and communities by lessening damage and trauma following a large earthquake. Retrofitting is one action we can take to avoid a future disaster involving injuries, loss of life, and loss of shelter and employment. Usually, buildings that are most valuable to a community, like hospitals and schools, are targeted first for retrofit.

The first step on the journey of retrofitting a building is assessment. An experienced engineer can quickly determine if a building has any serious weaknesses. A soft story (see Article 11) or discontinuous walls (Article 12), for example, might cause collapse in a damaging earthquake. The building age gives an indication of the probable standard of design and construction. For example, the first concrete buildings designed to survive intense shaking were built from the 1980s onwards. Materials of construction are very relevant. Based on their poor performance in past earthquakes, unreinforced masonry buildings are usually the first requiring retrofit.

If an initial assessment shows retrofitting is required, then more detailed engineering investigation and analysis is required. Small areas of demolition will show if certain crucial reinforcing details are safe (Figure 1).

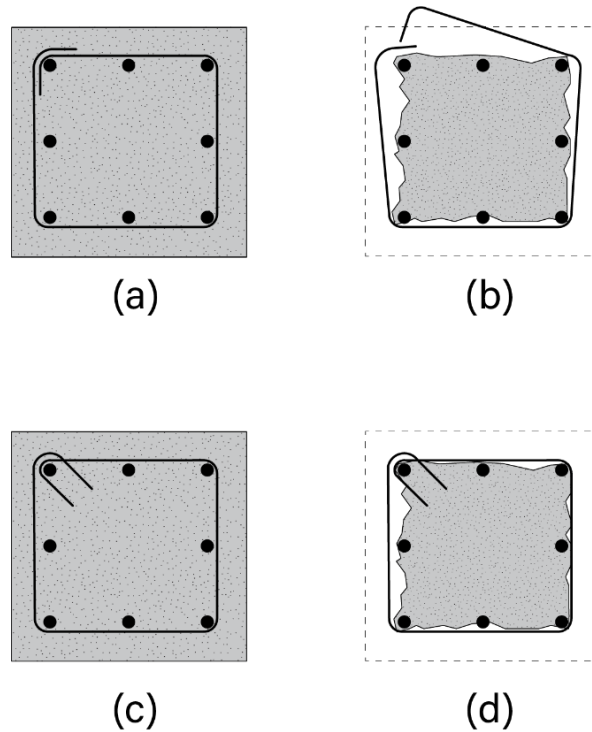

Figure 1. (a) shows a column cross-section where the ties have only a 90 degree bend. When the column is inevitably damaged during an earthquake, the bend just opens out and the tie is useless (b). In (c) the tie has been bent properly, and in accordance with code, with a 135 degree bend. When the column is damaged the tie is still effective (d).

An important question requiring discussion with building departments is what should be the level or standard of retrofit? Should the building be brought up to a standard required of a new building, or is a lesser level, but with greater risk of damage, acceptable? Given the relatively high cost of retrofitting, compromises are often made. All this work culminates in detailed retrofit plans and specifications.

Retrofitting solutions vary greatly. Every building must be treated individually, just like doctors treat patients. Some buildings need more interventions than others. Perhaps new structural elements such as structural walls or cross-bracing, both along and across the building (Figures 2-5). Others, may need new structural elements in just one direction. In other buildings, it may be enough to reduce their weight by removing and replacing heavy masonry walls. Sometimes the existing structure can't be improved and needs to be replaced. An online search for "retrofitting buildings for earthquakes" reveals many examples.



Figure 2. The seismic retrofit of this hospital building included two new structural walls and foundation at each end.

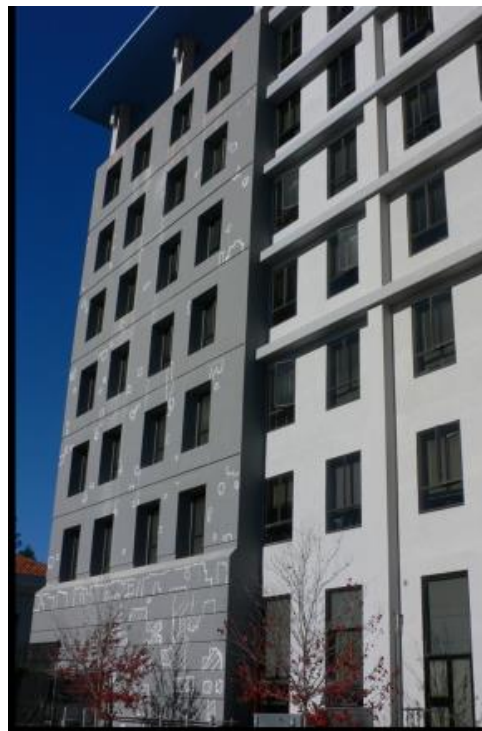

Figure 3. The thicker construction at the end of this building is a new concrete framework cast onto the existing structure for improved earthquake performance.



Figure 4. Bays of steel bracing are inserted into this building as part of the retrofit.



Figure 5. A timber floor of a masonry building is strengthened for earthquake resistance by steel bracing underneath it.

Finally, retrofit is usually an expensive process. In many situations it is unaffordable. Yet a relatively cheap solution is available for adobe houses (Vargas-Neumann 2011). Although there might be no option other than to live and work in vulnerable buildings for now, the way ahead is to ensure new buildings are safe. Then, over time, the building stock will gradually become safer in earthquakes.

About this article series:

This is a series of articles about earthquakes, their effects on buildings, and how to ensure that buildings are safe against earthquakes. They are intended for potential owners of new houses and larger buildings and others involved in the building industry. The articles are written by Andrew Charleson and colleagues from the World Housing Encyclopedia (<http://www.world-housing.net/>) which is sponsored by the Earthquake Engineering Research Institute (<https://www.eeri.org/>) and the International Association of Earthquake Engineering (<http://www.iaee.or.jp/>).

References:

Charleson, A. W., 2008. Seismic design for architects: outwitting the quake. Oxford, Elsevier, pp. 187-205.

Retrofit. Mitigation Center. Earthquake Engineering Research Institute. <https://mitigation.eeri.org/category/structures/retrofit-abc-testing>.

Murty, C. V. R., et al., 2006. At risk: the seismic performance of RC frame buildings with masonry infill walls. California, World Housing Encyclopedia. http://www.world-housing.net/wp-content/uploads/2011/05/RCFrame_Tutorial_English_Murty.pdf (accessed 8 June 2020).

Vargas-Neumann, J., et al., 2011. Building hygienic and earthquake-resistant adobe houses using geomesh reinforcement. http://www.world-housing.net/wp-content/uploads/2011/06/Adobe-Geomesh-Arid_Tutorial_English_Blondet.pdf.

Earthquake-safe Buildings

Article 23. Advanced Earthquake-Resilient Approaches for Buildings

Civil engineers around the globe believe an important building design principle against earthquakes is to create strong foundations to support the superstructure. However, an irony is that while strong foundations prevent buildings from sinking or toppling during an earthquake, they simultaneously transmit ground shaking into the superstructure. This results in stronger shaking within the stories above ground.

The breakthrough was seismic isolation, an approach initially applied in the 1960s. In this technique, the superstructure of a building is largely isolated from the effects of ground shaking. This is usually achieved by placing bearings, flexible against horizontal movement, between the foundations, at the base of a building, and the superstructure above (Figures 1 and 2). Hence it is commonly known as base-isolation. When the ground shakes, only a fraction of potential earthquake forces is transferred through the flexible bearings to the structure above. It's rather like placing the superstructure on ball-bearings!

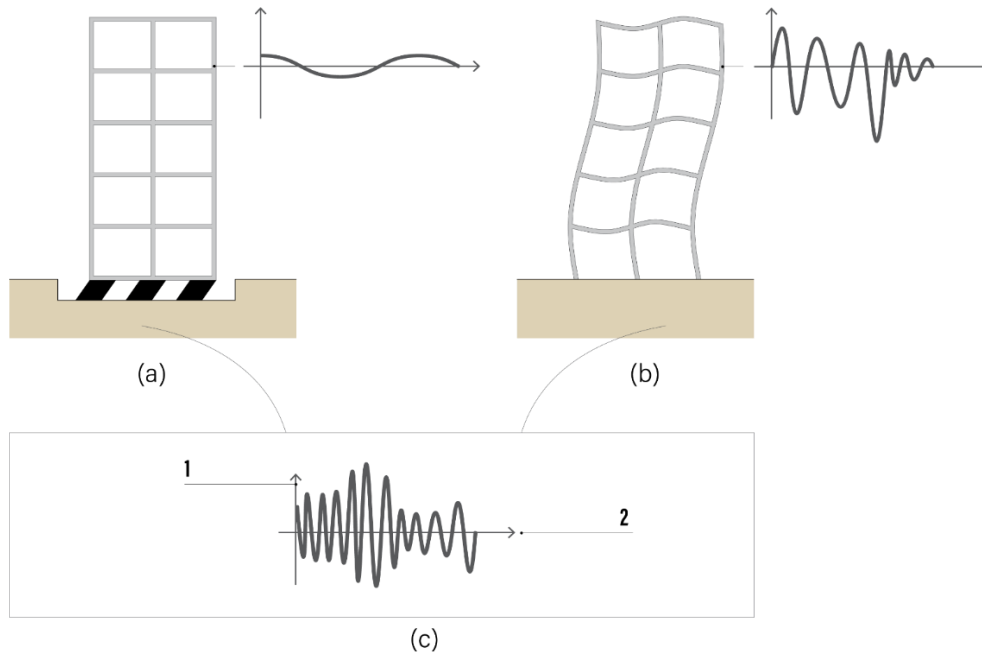

Figure 1. (a) A base-isolated building moves as a whole above its bearings while (b) shows how a conventional building bends up its height. Both buildings experience an earthquake record (c) where (1) is acceleration and (2) is time. Notice how the shaking in (a) is less and gentler than that of (b).



Figure 2. Two black and cylindrical isolation bearings under a building. Each bearing is bolted to a concrete base attached to the foundation and the base of a column that rises up the building.

The first bearings were large blocks of rubber and steel plate sandwich construction. Later, a lead plug was inserted to absorb some of the earthquake energy. Since then, other types of bearings have been produced, such as the friction pendulum system. It works by allowing sliding between two curved smooth surfaces. They can be viewed by searching online for “seismic isolation devices”.

Seismic isolation is the gold standard for earthquake resistance. It offers the best protection for the structure, non-structural elements like partitions and cladding, and building contents. Most new hospitals in seismic regions like Japan, California and New Zealand incorporate seismic isolation.

However, other approaches are also being introduced to make buildings safer in earthquakes. For example, devices called dampers are installed up the height of a building to reduce the intensity of earthquake shaking. Dampers act like, and sometimes look like, car shock absorbers (Figure 3). Very effective in damping down vibrations they are often placed at the top or bottom of diagonal braces (Figure 4). An alternative approach, where the whole brace functions as a both a brace and a damper is known as a “buckling restrained brace” (Figure 5).



Figure 3. A damper to reduce earthquake movements.

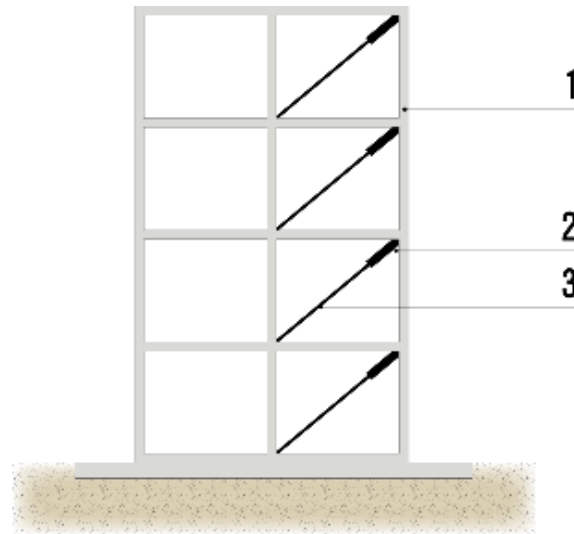

Figure 4. A frame building of columns and beams (1) with dampers (2) at the tops of diagonal braces (3).



Figure 5. Two buckling-restrained braces resist and dampen down movement in an earthquake.

Another new approach known as damage-avoidance design is becoming popular. Conventional structures like walls and frames that are capable of resisting earthquake are specially designed so that during an earthquake their primary members are not damaged. Rather, structural damage is confined to replaceable energy absorbers (Figures 6 and 7).

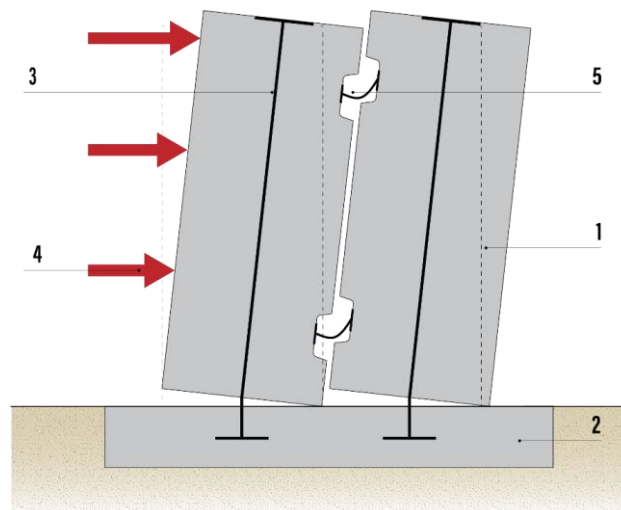

Figure 6. Two concrete walls side by side (1) connected to the foundations (2) by steel tendons (3) which stretch during earthquake loads (4). Steel plates (5) are distorted, absorbing energy and reducing resonance.



Figure 7. An earthquake energy absorber located between two rocking walls.

All the techniques mentioned above are far more sophisticated than conventional design and construction approaches. Therefore, only the most experienced and competent civil engineers should implement them.

About this article series:

This is a series of articles about earthquakes, their effects on buildings, and how to ensure that buildings are safe against earthquakes. They are intended for potential owners of new houses and larger buildings and others involved in the building industry. The articles are written by Andrew Charleson and colleagues from the World Housing Encyclopedia (<http://www.world-housing.net/>) which is sponsored by the Earthquake Engineering Research Institute (<https://www.eeri.org/>) and the International Association of Earthquake Engineering (<http://www.iaee.or.jp/>).

References:

Advanced Technologies Introduction. World Housing Encyclopedia, EERI. <https://www.world-housing.net/major-construction-types/advanced-technologies-introduction>.

BRANZ. Concrete structures: techniques and devices used to create a low-damage buildings using concrete. <http://www.seismicresilience.org.nz/topics/superstructure/commercial-buildings/concrete-structures/> (accessed 15 June 2020).

Charleson, A. W., and Guisasola, A., 2017. Seismic isolation for architects. London, Routledge.

Equipped with base isolation and/or energy dissipation devices. Glossary for GEM Taxonomy. Global Earthquake Model. <https://taxonomy.openquake.org/terms/equipped-with-base-isolation-and-or-energy-dissipation-devices-dbd>.

Earthquake-safe Buildings

Article 24. Urban Planning and Earthquake Safety

Compared to previous articles, this article takes a broader perspective. It discusses how urban planning can reduce an earthquake's destructive impact upon a region, city or community. Just like public health initiatives, such as provision of drinking water and sanitation prevent widespread disease, urban planning can reduce the effects of an earthquake and facilitate recovery.

Urban planners need seismic hazard maps to guide development. Such maps identify the presence of active fault zones (which development should avoid at all cost), and areas likely to experience greater shaking due to deep soft soils (Figure 1). These maps also indicate areas prone to liquefaction, landslide or rockfall during earthquake, and to tsunami inundation. With this information, planners can locate essential facilities, like fire stations and hospitals in safe areas and avoid locating housing in unsafe areas. The most hazardous areas might be designated as parks. An online search for "city seismic hazard map" will reveal many examples of these maps from around the world.

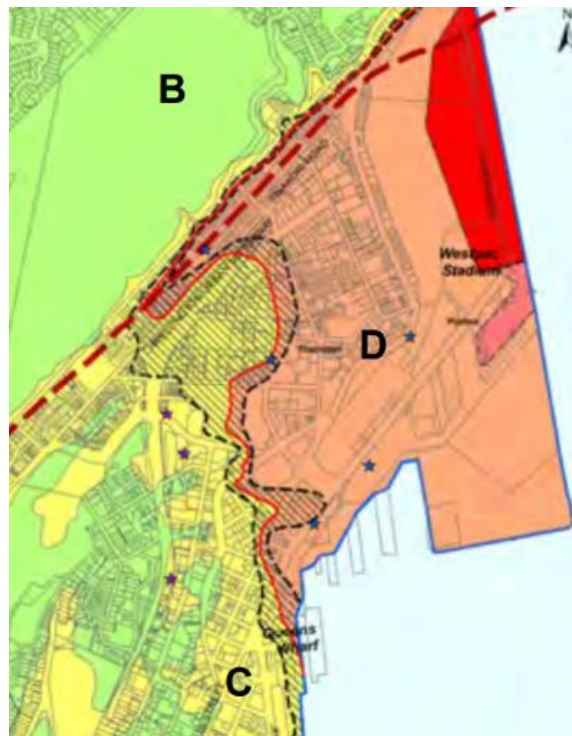

Figure 1. A ground shaking map for part of Wellington, New Zealand. Zone B will experience the least intense shaking, followed by C. D signifies the area of almost the worst shaking, with it peaking in the red area (Wellington City Council).

Another useful tool for planners is a seismic vulnerability map. This shows the relative earthquake vulnerability of the building stock in a certain area based on building surveys and engineering analysis (Figure 2). When used in conjunction with a seismic hazard map, geographical distribution of likely earthquake damage can inform the planning process. For example, city authorities might use this information to purchase rows of properties in the most vulnerable areas to increase street widths. This would reduce day-to-day congestion, enhance access by emergency services and provide wider fire breaks in anticipation of post-earthquake fires. Or authorities might require and assist owners of vulnerable buildings to upgrade them to protect a specific precinct of historical importance before it is lost in a large earthquake.

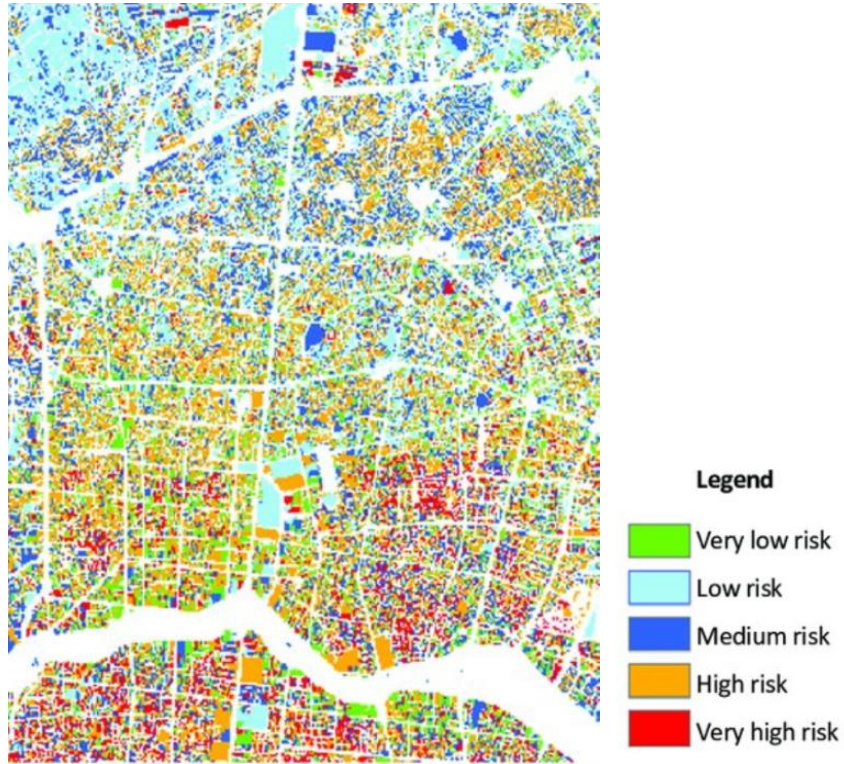

Figure 2. An earthquake vulnerability map of a city showing risk associated with building types and other factors (M. Tafti).

Urban planners need to work as members of interdisciplinary teams that include structural engineers. This is because in the past some cities have introduced regulations that unintentionally lead to buildings that are less earthquake-safe. For example, requirements to increase ground floor parking can result in buildings with soft stories (Article 11), and permission to allow buildings to project out above the footpath into the street can lead to discontinuous walls (Article 12).

About this article series:

This is a series of articles about earthquakes, their effects on buildings, and how to ensure that buildings are safe against earthquakes. They are intended for potential owners of new houses and larger buildings and others involved in the building industry. The articles are written by Andrew Charleson and colleagues from the World Housing Encyclopedia (<http://www.world-housing.net/>) which is sponsored by the Earthquake Engineering Research Institute (<https://www.eeri.org/>) and the International Association of Earthquake Engineering (<http://www.iaee.or.jp/>).

References:

Charleson, A. W., 2008. Seismic design for architects: outwitting the quake. Oxford, Elsevier, pp. 233-242.

Earthquake-safe Buildings

Article 25. Tsunamis and Buildings

The devastating 26 December 2004 Sumatra, Indonesia earthquake and Indian Ocean tsunami has intensified awareness of this oceanic earthquake hazard. Large stretches of coastline around the Pacific Rim and elsewhere are at risk of tsunami inundation. The destruction and loss of life from tsunamis is well documented in the histories of tens of villages and cities world-wide. A tsunami exerts large horizontal forces on any surfaces preventing its flow. Wood buildings offer no protection from tsunami, and stone, brick and concrete buildings may be destroyed at flow depths up to two meters, depending on the speed of the water.

The starting point for architects and planners in ascertaining the risk of tsunami is to obtain an inundation map of the area of interest (Figure 1). This information may be included in a seismic hazard map (Article 24). With an appreciation of the uncertainties and assumptions that affect the accuracy of such information, damage reduction measures can be considered. The number of options appears to be limited to the construction of tsunami walls or barriers, planting dense areas of low trees, and relocation. The Japanese have protected fishing villages by massive reinforced concrete walls. A very expensive option with considerable adverse environmental impacts, walls are far more effective than wide plantings. Although plantings absorb some of the tsunami energy, they also add to the volume of water-borne debris. Relocation of tsunami-affected settlements has been undertaken in a number of countries.

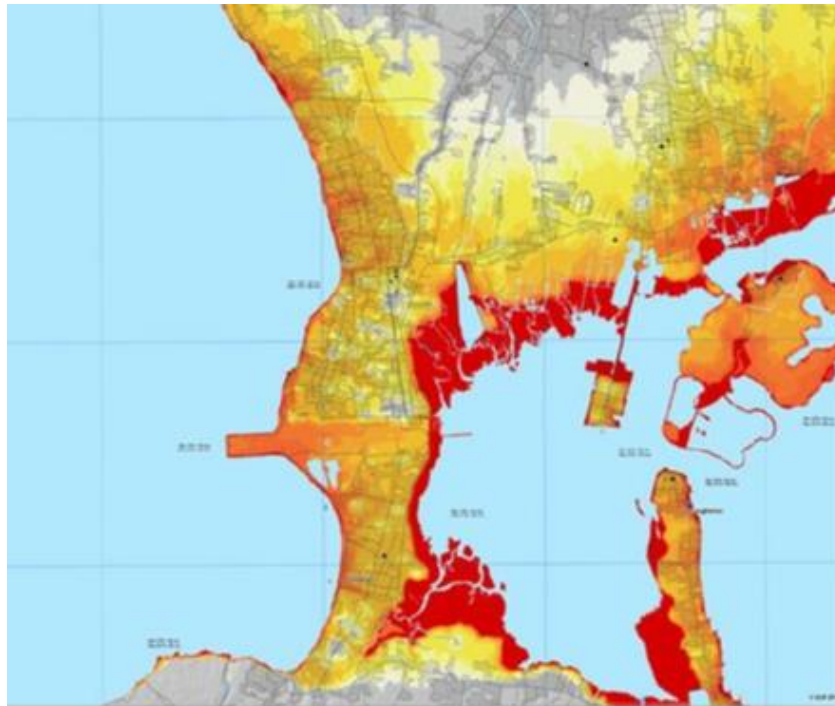

Figure 1. A typical tsunami hazard map, in this case of Bali. Darker colors indicate a greater probability of hazard (S. Wegscheider).

Tsunami early-warning systems and identification and provision of evacuation routes are also effective methods to reduce loss of life (Figure 2). But in some areas, tsunami flow can inundate low-lying coastal land many kilometers inland. With warning periods measured only in minutes there is nowhere safe to flee. For many such 'at-risk' people, what are termed 'tsunami vertical evacuation centers' are the only chance of survival (Figure 3).

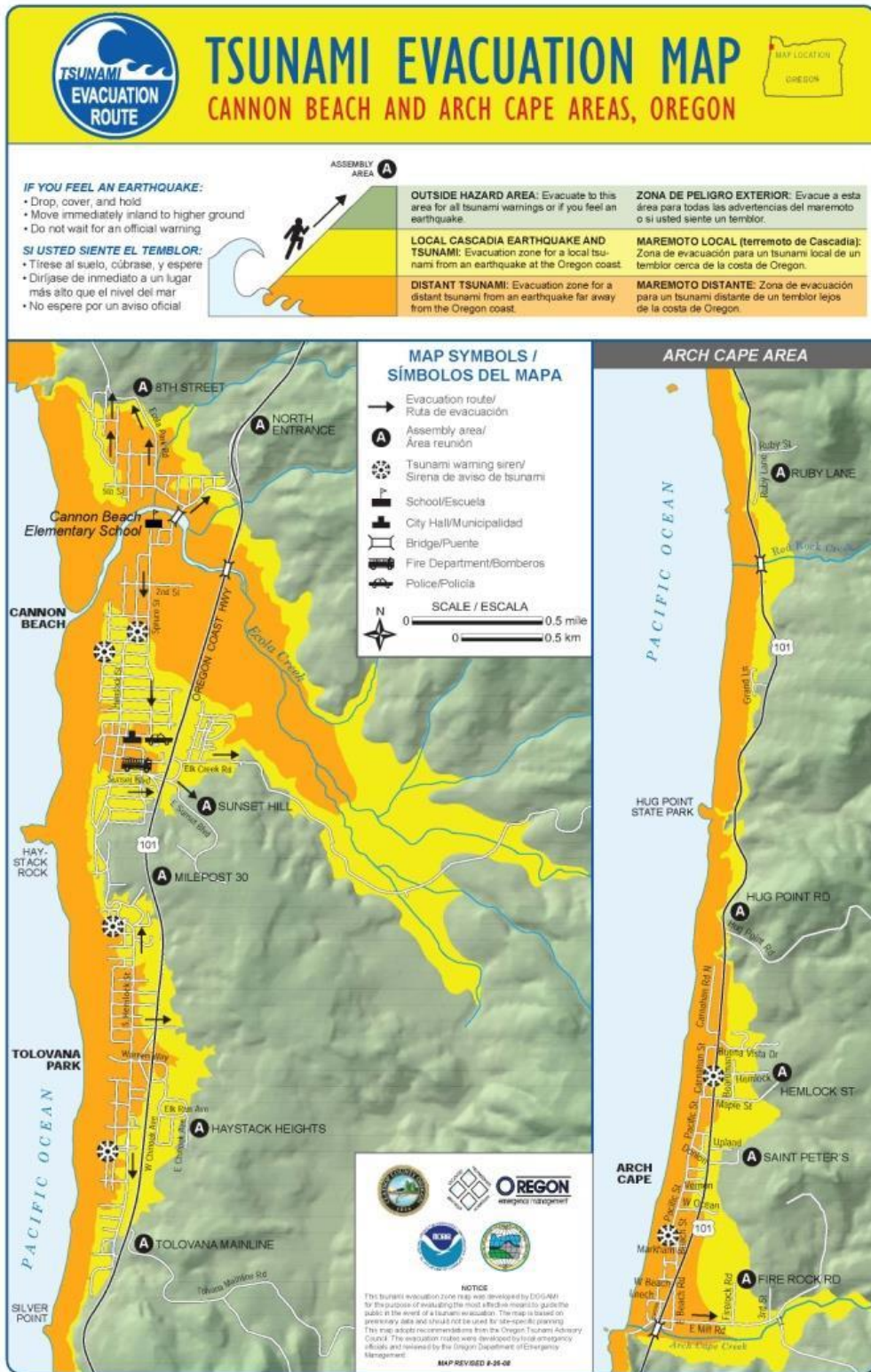

Figure 2. A typical tsunami evacuation map (Oregon State University).



Figure 3. A private tsunami evacuation center. Most evacuation centers are for the nearby community.

The primary requirement of a tsunami shelter is to accommodate evacuees above the expected inundation level. As far as the structural design properties of a shelter are concerned, it must first be designed to resist earthquake forces from ground shaking. This means it must be designed to a higher standard than usual. It must also comply with every code requirement to ensure its earthquake safety. Then it must be checked it can withstand the considerable water pressures plus impact forces from water-borne debris.

About this article series:

This is a series of articles about earthquakes, their effects on buildings, and how to ensure that buildings are safe against earthquakes. They are intended for potential owners of new houses and larger buildings and others involved in the building industry. The articles are written by Andrew Charleson and colleagues from the World Housing Encyclopedia (<http://www.world-housing.net/>) which is sponsored by the Earthquake Engineering Research Institute (<https://www.eeri.org/>) and the International Association of Earthquake Engineering (<http://www.iaee.or.jp/>).

References:

National Tsunami Hazard Mitigation Program, 2001. Designing for tsunamis: seven principles for planning and designing for tsunami hazards. <https://nws.weather.gov/nthmp/documents/designingfortsunamis.pdf> (accessed 16 June 2020).

Wegscheider, S, et al., 2011. Generating tsunami risk knowledge at community level as a base for planning and implementation of risk reduction strategies, *Nat. Hazards Earth Syst. Sci.*, 11, 249–258.